

Programmable Controller CQM1(H)

Replacement Guide From CQM1(H) to CJ2M

CQM1H-CPU□1

CJ2M-CPU□□



Replace
Guide

About this document

This document provides the reference information for replacing CQM1H PLC systems with CJ2M series PLC.

This document does not include precautions and reminders; please read and understand the important precautions and reminders described on the manuals of PLCs (both of PLC used in the existing system and PLC you will use to replace the existing PLC) before attempting to start operation.

Related Manuals

Man.No.	Manual
W472	CJ2 CPU Unit Hardware USER'S MANUAL
W473	CJ2 CPU Unit Software USER'S MANUAL
W486	CJ2M Pulse I/O Module USER'S MANUAL
W393	CJ Series OPERATION MANUAL
W441	CJ series CJ1M CPU Units with Ethernet Functions OPERATION MANUAL
W395	CJ series Built-in I/O CJ1M CPU Units OPERATION MANUAL
W394	CS/CJ/NSJ PROGRAMMING MANUAL
W474	CS/CJ/NSJ Series INSTRUCTIONS REFERENCE MANUAL
W342	CS/CJ/CP/NSJ Series Communications Commands REFERENCE MANUAL
W345	CS/CJ Series Analog I/O Units AD/DA/MAD42 OPERATION MANUAL
W368	CS/CJ Series Analog I/O Units OPERATION MANUAL
W466	CJ Series Universal Input Units OPERATION MANUAL
W396	CJ Series Temperature Control Units OPERATION MANUAL
W401	High-speed Counter Units OPERATION MANUAL
W465	EtherNet/IP Units OPERATION MANUAL
W420	CS and CJ Series Ethernet Units OPERATION MANUAL Construction of Networks
W343	CS/CJ Series Ethernet Units OPERATION MANUAL
W421	CS/CJ Series Ethernet Units OPERATION MANUAL Construction of Applications
Z174	CS/CJ Series ID SENSOR UNITS OPERATION MANUAL
W397	CJ Series Position Control Units CJ1W-NC□□3 OPERATION MANUAL
W477	CJ Series Position Control Units CJ1W-NC□□4 OPERATION MANUAL
W336	CS/CJ Series Serial Communications Boards Serial Communications Units OPERATION MANUAL
W426	CS/CJ Series Position Control Units CS1W-NC□□1/CJ1WNC□□1-MA OPERATION MANUAL
W435	CS/CJ series Motion Control Unit CS1W/CJ1W-MCH71OPERATION MANUAL
W467	Controller Link Support Boards for PCI Bus INSTALLATION GUIDE
W309	Controller Link Units OPERATION MANUAL
V237	SPU-Console Ver.2.1 OPERATION MANUAL
W406	CS/CJ Series Loop Control Boards/Process-control CPU Units /Loop-control CPU Units OPERATION MANUAL
W407	CS/CJ Series Loop Control Boards/Process-control CPU Units /Loop-control CPU Units FUNCTION BLOCK REFERENCE MANUAL
W364	CQM1H Series Programmable Controllers Inner Boards PROGRAMMING MANUAL
W365	CQM1H-SCB41 SERIAL COMMUNICATIONS BOARD OPERATION MANUAL
W238	CQM1H/CQM1 Series Dedicated I/O Units OPERATION MANUAL
W364	CQM1H Series Programmable Controllers Inner Boards PROGRAMMING MANUAL
W463	CX-One FA Integrated Tool Package SETUP MANUAL
W446	CX-Programmer OPERATION MANUAL
W447	CX-Programmer OPERATION MANUAL :Function Blocks/Structured Text
W469	CX-Programmer OPERATION MANUAL SFC Programming
W366	CX-Simulator OPERATION MANUAL
W464	CX-Integrator OPERATION MANUAL
W433	CX-Position OPERATION MANUAL
W436	CX-Motion-NCF OPERATION MANUAL
W448	CX-Motion-MCH OPERATION MANUAL

Terms and Conditions Agreement

Read and understand this catalog.

Please read and understand this catalog before purchasing the products. Please consult your OMRON representative if you have any questions or comments.

Warranties.

(a) Exclusive Warranty. Omron's exclusive warranty is that the Products will be free from defects in materials and workmanship for a period of twelve months from the date of sale by Omron (or such other period expressed in writing by Omron). Omron disclaims all other warranties, express or implied.

(b) Limitations. OMRON MAKES NO WARRANTY OR REPRESENTATION, EXPRESS OR IMPLIED, ABOUT NON-INFRINGEMENT, MERCHANTABILITY OR FITNESS FOR A PARTICULAR PURPOSE OF THE PRODUCTS. BUYER ACKNOWLEDGES THAT IT ALONE HAS DETERMINED THAT THE PRODUCTS WILL SUITABLY MEET THE REQUIREMENTS OF THEIR INTENDED USE. Omron further disclaims all warranties and responsibility of any type for claims or expenses based on infringement by the Products or otherwise of any intellectual property right.

(c) Buyer Remedy. Omron's sole obligation hereunder shall be, at Omron's election, to (i) replace (in the form originally shipped with Buyer responsible for labor charges for removal or replacement thereof) the non-complying Product, (ii) repair the non-complying Product, or (iii) repay or credit Buyer an amount equal to the purchase price of the non-complying Product; provided that in no event shall Omron be responsible for warranty, repair, indemnity or any other claims or expenses regarding the Products unless Omron's analysis confirms that the Products were properly handled, stored, installed and maintained and not subject to contamination, abuse, misuse or inappropriate modification. Return of any Products by Buyer must be approved in writing by Omron before shipment. Omron Companies shall not be liable for the suitability or unsuitability or the results from the use of Products in combination with any electrical or electronic components, circuits, system assemblies or any other materials or substances or environments. Any advice, recommendations or information given orally or in writing, are not to be construed as an amendment or addition to the above warranty.

See <http://www.omron.com/global/> or contact your Omron representative for published information.

Limitation on Liability; Etc.

OMRON COMPANIES SHALL NOT BE LIABLE FOR SPECIAL, INDIRECT, INCIDENTAL, OR CONSEQUENTIAL DAMAGES, LOSS OF PROFITS OR PRODUCTION OR COMMERCIAL LOSS IN ANY WAY CONNECTED WITH THE PRODUCTS, WHETHER SUCH CLAIM IS BASED IN CONTRACT, WARRANTY, NEGLIGENCE OR STRICT LIABILITY.

Further, in no event shall liability of Omron Companies exceed the individual price of the Product on which liability is asserted.

Suitability of Use.

Omron Companies shall not be responsible for conformity with any standards, codes or regulations which apply to the combination of the Product in the Buyer's application or use of the Product. At Buyer's request, Omron will provide applicable third party certification documents identifying ratings

and limitations of use which apply to the Product. This information by itself is not sufficient for a complete determination of the suitability of the Product in combination with the end product, machine, system, or other application or use. Buyer shall be solely responsible for determining appropriateness of the particular Product with respect to Buyer's application, product or system. Buyer shall take application responsibility in all cases.

NEVER USE THE PRODUCT FOR AN APPLICATION INVOLVING SERIOUS RISK TO LIFE OR PROPERTY OR IN LARGE QUANTITIES WITHOUT ENSURING THAT THE SYSTEM AS A WHOLE HAS BEEN DESIGNED TO ADDRESS THE RISKS, AND THAT THE OMRON PRODUCT(S) IS PROPERLY RATED AND INSTALLED FOR THE INTENDED USE WITHIN THE OVERALL EQUIPMENT OR SYSTEM.

Programmable Products.

Omron Companies shall not be responsible for the user's programming of a programmable Product, or any consequence thereof.

Performance Data.

Data presented in Omron Company websites, catalogs and other materials is provided as a guide for the user in determining suitability and does not constitute a warranty. It may represent the result of Omron's test conditions, and the user must correlate it to actual application requirements. Actual performance is subject to the Omron's Warranty and Limitations of Liability.

Change in Specifications.

Product specifications and accessories may be changed at any time based on improvements and other reasons. It is our practice to change part numbers when published ratings or features are changed, or when significant construction changes are made. However, some specifications of the Product may be changed without any notice. When in doubt, special part numbers may be assigned to fix or establish key specifications for your application. Please consult with your Omron's representative at any time to confirm actual specifications of purchased Product.

Errors and Omissions.

Information presented by Omron Companies has been checked and is believed to be accurate; however, no responsibility is assumed for clerical, typographical or proofreading errors or omissions.

Microsoft products screen shot(s) reprinted with permission from Microsoft Corporation.

Other company names and product names in this document are the trademarks or registered trademarks of their respective companies.

Table of Contents

TABLE OF CONTENTS	1
WORK FLOW	2
1. PERFORMANCE SPECIFICATIONS	3
1.1 CQM1H/CJ2M SPECIFICATIONS COMPARISON	3
2. SYSTEM CONFIGURATIONS	4
2.1 CQM1H/CJ2M SYSTEM CONFIGURATION COMPARISON	4
3. MEMORY AREA	9
3.1 CQM1H/CJ2M MEMORY AREA COMPARISON	9
4. I/O AREA ALLOCATION	11
5. INSTRUCTIONS	13
5.1 HIGH-SPEED COUNTER/PULSE OUTPUT INSTRUCTION	13
5.2 I/O INSTRUCTIONS	29
5.3 MODEL CONVERSION INSTRUCTIONS	34
6. EXAMPLE OF CONVERTING LADDER PROGRAM BY CX-PROGRAMMER	35

Appendix

A-1 Instruction operations

A-2 Condition flag operations

This replacement guide describes the procedure to rebuild the system which uses the CQM1H-series PLC by introducing the CJ2M-series PLC instead. The CJ2M-series has functions which can replace the functions and operation of CQM1H-series PLC. Take the below work flow to replace your system. Also, refer to the reference pages for details.

Work flow

1) Preliminary Steps: Take the following steps before starting the replacement work.

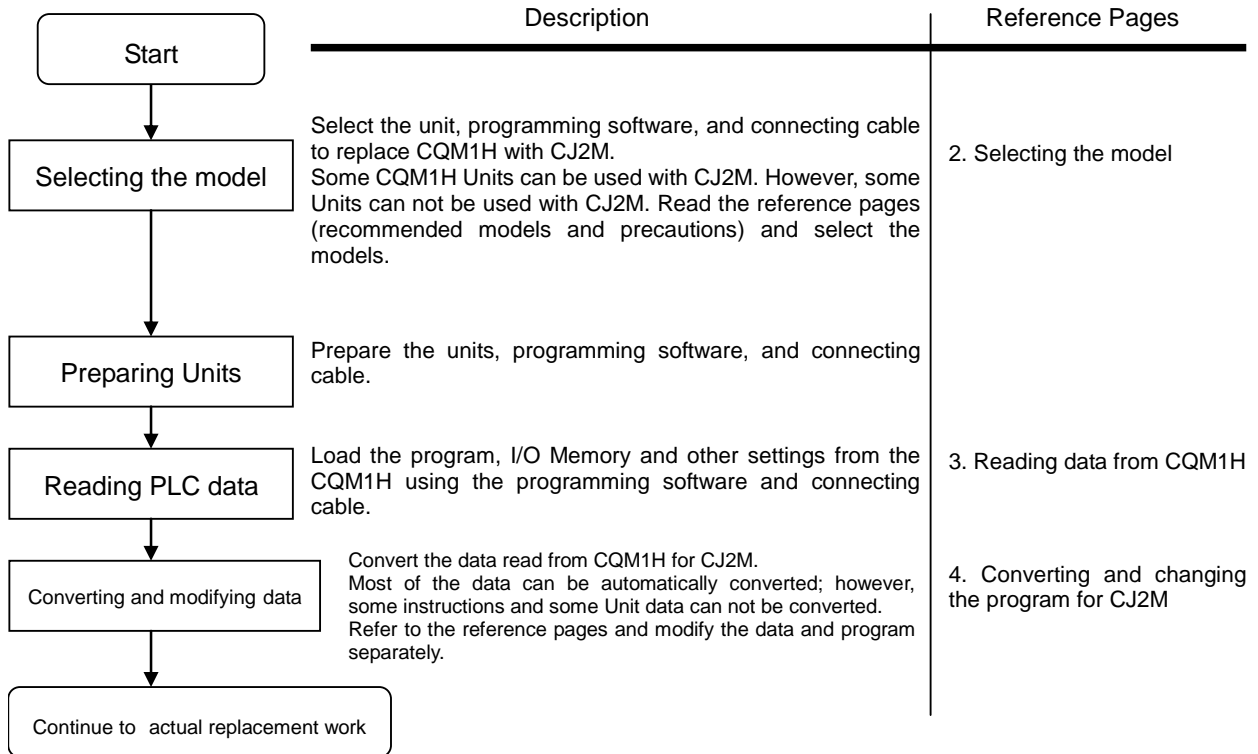

2) Actual replacement work: Take the steps below to replace the CQM1(H) to CJ2M.

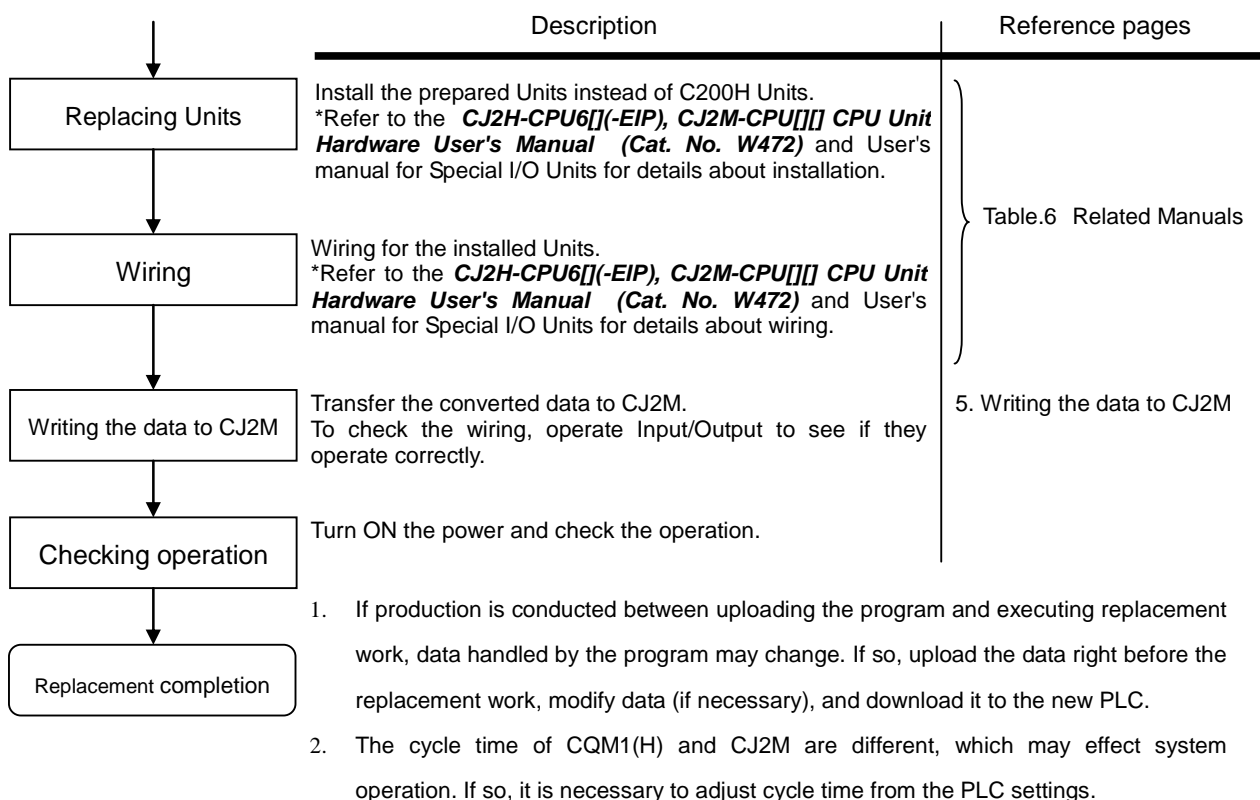

1. Performance specifications

1.1 CQM1H/CJ2M specifications comparison

The table below lists the major difference in specifications of the CQM1H series and CJ2M series.

Item		CQM1H-CPU11/21/51/61	CJ2M-CPU**
Number of I/O points		CPU11/21: 256 points CPU51/61: 512 points	2,560 points
Program capacity		Note1. CPU11/21: 3.2k words CPU51: 7.2k words CPU61: 15.2k words	Note1. CPU*1: 5k step CPU*2: 10k step CPU*3: 20k step CPU*4: 30k step CPU*5: 60k step
Data memory		CPU11/21: 3.k words (DM) CPU51: 6k words (DM) CPU61: 12k words (DM + EM)	32k words EM CPU*1 to *3: 1 bank (32k) CPU*4 to *5: 4 banks (32k x 4)
Built-in I/O		In:16 points	Built-in CPU function will be available by adding the CJ2M-MD211/CJ2M-MD212. Up to two units can be mounted. In: 10 points/Out: 6 points (when one unit is used). In: 20 points/Out: 12 points (when two units are used). Attention: It is possible to use the unit with the CPU Unit of unit version 2.0 or later.
Length of instructions		Note1. 1-4 words/one instruction	Note1. 1-30 steps/one instruction
Execution time of instruction	LD instruction	0.375us	0.04us
	MOV instruction	17.7us	0.12us
Overhead processing time		0.70ms	CPU3*: 270us CPU1*: 160us
Maximum Number of Connectable Units		16 units	40 units
Maximum Number of Expansion Racks		1	3
Clock function		Available. Optional memory cassette is necessary.	Equipped as a standard function.
Dimensions (CPU Unit)		110(H)x187(W)x107(D)	CPU1*: 90(H)x31(W)x75(D) CPU3*: 90(H) x 62(W) x 75(D)
Programming software		SSS,CPT,CX-P	CX-P
Programming device connection	Programming device for personal computer	< Peripheral port connection > Connection with PC requires cables: CS1W-CN*** or CS1W-CN114 + CQM1-CIF**. < RS232 C port connection > Connection with PC requires a cable: XW2Z-***S (-V).	< Peripheral (USB) port > A direct connection can be made between the USB port of the personal computer and the PLC using the commercially-available USB cable. < Serial (RS232C) port connection > Use the serial cable (XW2Z-200S-CV/500S-CV) to connect the PC and serial port on the CPU Unit. (The CPU3* does not have the RS232C port on it. Mount the RS232C option board (CP1W-CIF01) and connect the cable with the unit).
	Programming Console	Available C200H-PRO27 CQM1-PRO01	Not available

Note1. One word of CQM1H corresponds to one step of CJ2M. For instance, replacement model of CQM1H-CPU51 (7.2k word) is CJ2M-CPU*2 (10k step), since the program capacity of 7.2k step or larger is required for replacement.

Note that the number of steps for an instruction might be different in CQM1H and CJ2M.

< Example > TIM instruction: CQM1H: 2 word/CJ2M: 3 step

2. System Configurations

2.1 CQM1H/CJ2M system configuration comparison

This section describes the CJ2M series units which can be used instead of the CQM1H series units.

Functions which have been supported by the CQM1H series unit can be generally supported by the CJ2M series unit. However, there are some differences in usage, connecting method with external devices, and input/output specifications. Please check if the CJ series unit can be used instead of the CQM1H units, by referring to the user's manuals of both series.

◆ Power Supply Unit

Unit	CQM1H	CJ2M
AC Power Supply Unit	CQM1-PA203	CJ1W-PA202
	100 to 240 VAC, 50/60Hz Output capacity 18W, No DC service power supply	100 to 240 VAC, 50/60Hz Output capacity 14W, No DC service power supply
AC Power Supply Unit	CQM1-PA206	CJ1W-PA205R
	100 to 240 VAC, 50/60Hz Output capacity 30W DC service power supply 24VDC/0.5A	100 to 240 VAC, 50/60Hz Output capacity 25W No DC service power supply, with RUN output
DC Power Supply Unit	CQM1-PD026	CJ1W-PD025
	24VDC, output capacity 30W	24VDC, output capacity 25W

◆ Inner Boards

Unit	CQM1H	CJ2M
High-speed counter board	CQM1H-CTB41 No. of counters: 4	CJ1W-CT021 x 2units No. of counters: 2
Pulse I/O board	CQM1H-PLB21 2 pulse inputs, 2 pulse outputs	CJ2M-MD211 (Sinking type) /CJ2M-MD212 (Sourcing type) * 2 high-speed counters (pulse inputs), 2 pulse outputs
Absolute encoder interface board	CQM1H-ABB21 2 absolute encoder (binary gray code) inputs	None (Absolute encoder inputs: Redesign)
Analog setting board	CQM1H-AVB41 4 analog settings	None (Analog interface: Redesign)
Analog I/O board	CQM1H-MAB42 4 analog inputs, 2 analog outputs	CJ1W-MAD42 4 analog inputs, 2 analog outputs
Serial communications board	CQM1H-SCB41 RS-232C x1port + RS-422A/485 x1port	CJ1W-SCU41 RS-232C x1port + RS-422A/485 x1port

* For CPU Unit Ver.2.0 or later.

◆ Basic I/O Units

Unit	CQM1H	CJ2M	Remarks
DC Input Units	CQM1-ID211	CJ1W-ID201	1. Rewire. 2. Use Conversion Adapter CJ1W-AT411.
	Terminal block/12-24VDC/1 common per input x 8 points	Terminal block /12 to 24VDC/ 8 points	
	CQM1-ID111	CJ1W-ID201 x 2 units	Rewire. Replace with two units of ID201.
	Terminal block /12VDC/16 points	Terminal block /12 to 24VDC/ 8 points	
	CQM1-ID212	CJ1W-ID211 *	1. Rewire. 2. Use Conversion Adapter CJ1W-AT411.
	Terminal block /24VDC/16 points	Terminal block /24VDC/16 points	
	CQM1-ID112	CJ1W-ID201 x 4 units	Rewire. Replace with four units of ID201.
	Connector/12VDC/32 points	Terminal block /12 to 24VDC/ 8 points	
	CQM1-ID213	CJ1W-ID231 *	Existing I/O connector cable can be used.
	Connector/24VDC/32 points	Connector/24VDC/32 points	
CQM1-ID214	CJ1W-ID231	Existing I/O connector cable can be used.	
Connector/24VDC/32 points	Connector/24VDC/32 points		
AC Input Units	CQM1-IA121	CJ1W-IA111	Rewire.
	Terminal block /100 to 120VAC/8 points	Terminal block /100 to 120VAC/16 points	
	CQM1-IA221	CJ1W-IA201	Rewire.
	Terminal block /200 to 240VAC/8 points	Terminal block 200 to 240VAC 8 points Attention: Uses 1 word for unit area allocation.	
Relay output units	CQM1-OC221	CJ1W-OC201	Rewire.
	Terminal block/250VAC 24VDC 2A/8 points Independent common	Terminal block/250VAC 24VDC 2A/8points Independent common	
	CQM1-OC222	CJ1W-OC211	Rewire.
	Terminal block/250VAC 24VAC 2A/16 points	Terminal block/250VAC 24VDC 2A/16 points	
	CQM1-OC224	CJ1W-OC201	Rewire.
Terminal block/250VAC 24VDC 2A/8 points Independent common	Terminal block 250VAC 24VDC 2A/8 points Independent common		
Triac output units	CQM1-OA221	CJ1W-OA201	Rewire.
	Terminal block/100 to 240VAC 0.4A/8 points	Terminal block/250VAC 0.6A/8 points	
	CQM1-OA222	CJ1W-OA201	Rewire.
	Terminal block/100 to 240VAC 0.4A/6 points	Terminal block/250VAC 0.6A/8 points	

*1. The rated input voltage must be changed from 12 VDC to 24 VDC.

Unit	CQM1H	CJ2M	Remarks
Transistor Output Units	CQM1-OD211	CJ1W-OD201 Terminal block 12 to 24VDC 2A 8 points	Rewire.
	Terminal block/24VDC 2A/8 points	CJ1W-OD203 *2 Terminal block/12 to 24VDC 0.5A/8 points	Use Conversion Adapter CJ1W-AT411.
	CQM1-OD212	CJ1W-OD211 *3	1. Rewire. 2. Use Conversion Adapter CJ1W-AT411.
	Terminal block/4.5VDC 50mA to 26.4VDC 300mA/16 points	Terminal block/12 to 24VDC 0.5A/16 points	
	CQM1-OD213	CJ1W-OD231 *3	Existing I/O connector cable can be used.
	Connector/4.5VDC 16mA to 26.4VDC 100mA/32 points	Terminal block/12 to 24VDC 0.5A/32 points	
	CQM1-OD216	CJ1W-OD232	Rewire and change FCN connector to MIL connector.
	Connector/24VDC 500mA Sourcing type/32 points	Connector/24VDC 0.5A/32 points Load short-circuit protection	
	CQM1-OD214	CJ1W-OD212 *3	1. Rewire. 2. Use Conversion Adapter CJ1W-AT411.
	Terminal block/24VDC 300mA Sourcing type/16 points	Terminal block/24VDC 0.5A/16 points Load short-circuit protection	
CQM1-OD215	CJ1W-OD202 *4	1. Rewire. 2. Use Conversion Adapter CJ1W-AT411.	
Terminal block/24VDC 1.0A Sourcing type/8 points Short-circuit protection	Terminal block/24VDC 2A/8 points Load short-circuit protection and disconnected line detection		

*2. Check the maximum load current. Do not use when the load current is outside the specified range.

*3. Check the allowable voltage range.

*4. RST0, RST1, ALM0, and ALM1 cannot be used.

◆ Special I/O Unit

Unit	CQM1H	CJ2M
B7A Interface Units	CQM1-B7A12	CJ1W-B7A14
	16 inputs	64 inputs
	CQM1-B7A13	CJ1W-B7A14
	32 inputs	64 inputs
	CQM1-B7A02	CJ1W-B7A04
	16 outputs	64 outputs
	CQM1-B7A03	CJ1W-B7A04
	32 outputs	64 outputs
Analog input units	CQM1-B7A21	CJ1W-B7A22
	16 inputs/16 outputs	32 inputs / 32 outputs
Analog input units	CQM1-AD041	CJ1W-AD041-V1
	4 analog inputs -10 to +10 V, 0 to 10 V, 1 to 5 V, 4 to 20 mA	4 analog inputs 0 to 5V, -10 to+10 V, 0 to 10 V, 1 to 5 V, 4 to 20 mA
Analog output units	CQM1-DA021	CJ1W-DA 021
	2 analog outputs -10 to+10 V, 0 to 20 mA	2 analog outputs 1 to 5V, 4 to 20 mA, 0 to 5 V,-10 to+10 V, 0 to 10 V
CompoBus/S master units	CQM1-SRM21-V1	CJ1W-SRM21
DeviceNet I/O link units	CQM1-DRT21	CJ1W-DRM21
		(Use slave communications)
Temperature control units	CQM1-TC001	CJ1W-TC003
	Thermocouple input/Transistor (NPN) output/2 loops	Thermocouple input/Transistor (NPN) output/with heater burnout detection function
	CQM1-TC002	CJ1W-TC004
	Thermocouple input/Transistor (PNP) output/2 loops	Thermocouple input/Transistor (PNP) output/with heater burnout detection function
	CQM1-TC101	CJ1W-TC103
	Resistance thermometer input/Transistor (NPN) output/2 loops	Resistance thermometer input/Transistor (NPN) output/with heater burnout detection function
	CQM1-TC102	CJ1W-TC104
	Resistance thermometer input/Transistor (PNP) output/2 loops	Resistance thermometer input/Transistor (PNP) output/with heater burnout detection function
	CQM1-TC201	CJ1W-TC001
	Thermocouple input/Transistor (NPN) output/4 loops	Thermocouple input/Transistor (NPN) output/4 loops
	CQM1-TC202	CJ1W-TC002
	Thermocouple input/Transistor (PNP) output/4 loops	Thermocouple input/Transistor (PNP) output/4 loops
	CQM1-TC203	CJ1W-TC003
	Thermocouple input/Transistor (NPN) output/with heater burnout detection function	Thermocouple input/Transistor (NPN) output/with heater burnout detection function
	CQM1-TC204	CJ1W-TC004
	Thermocouple input/Transistor (PNP) output/with heater burnout detection function	Thermocouple input/Transistor (PNP) output/with heater burnout detection function
	CQM1-TC301	CJ1W-TC101
	Resistance thermometer input/Transistor (NPN) output/4 loops	Resistance thermometer input/Transistor (NPN) output/4 loops
	CQM1-TC302	CJ1W-TC102
	Resistance thermometer input/Transistor (PNP) output/4 loops	Resistance thermometer input/Transistor (PNP) output/4 loops
CQM1-TC303	CJ1W-TC103	
Resistance thermometer input/Transistor (NPN) output/with heater burnout detection function	Resistance thermometer input/Transistor (NPN) output/with heater burnout detection function	

Unit	CQM1H	CJ2M
	CQM1-TC304 Resistance thermometer input/Transistor (PNP) output/with heater burnout detection function	CJ1W-TC104 Resistance thermometer input/Transistor (PNP) output/with heater burnout detection function
SYSMAC BUS I/O link units	CQM1-LK501 SYSMAC BUS wired slave unit	None (Redesign system: DeviceNet is recommended.)
G730 interface units	CQM1-G7M21/G7N01/G7N11	None (Redesign system: CompoNet is recommended.)
Linear sensor interface units	CQM1-LSE01/02	None (Redesign system.)
Safety relay units	CQM1-SF200	None (Redesign system.)

3. Memory area

3.1 CQM1H/CJ2M memory area comparison

The difference of the memory area of the CQM1H series and CJ2M series is shown using an example of CQM1H-CPU61 and CJ2M-CPU**.

◆CIO area

CQM1H-CPU61		CJ2M-CPU**		
IR000	Input Area	0000	I/O Area	
IR015	Work area			
IR016				
IR089	Controller Link Status Area 1			
IR090				
IR095				
IR096				
IR096	MACRO operand Input area			
IR099	Output area			
IR100				
IR115	Work area	0159		
IR116		0160		Not used
IR189				
IR190	Controller Link Status Area 2			
IR195				
IR196	MACRO operand Output area			
IR199				
IR200	Inner Board slot 1 area			
IR215				
IR216	Work area			
IR219				
IR220	Inner board relay Analog settings area			
IR223				
IR224	Work area			
IR229				
IR230	High-speed Counter 0 PV			
IR231				
IR232	Inner Board slot 2 area			
IR243				
SR244	SR area			
SR255				
		0999		
		1000	Data Link Area	
		1199		
		1200	Not used	
		1299		
		1300	Internal I/O Area	
		1499		
		1500	CPU Bus Unit Area	
		1899		
		1900	Not used	
		1999		
		2000	Special I/O Unit Area	
		2959		
		2960	Pulse I/O Area	
		2963		
		2964	Not used	
		3099		
		3100	Serial PLC Link Area	
		3189		
		3190	Not used	
		3199		
		3200	DeviceNet Area	
		3799		
		3800	Internal I/O Area	
		6143		

◆ Area other than CIO Area

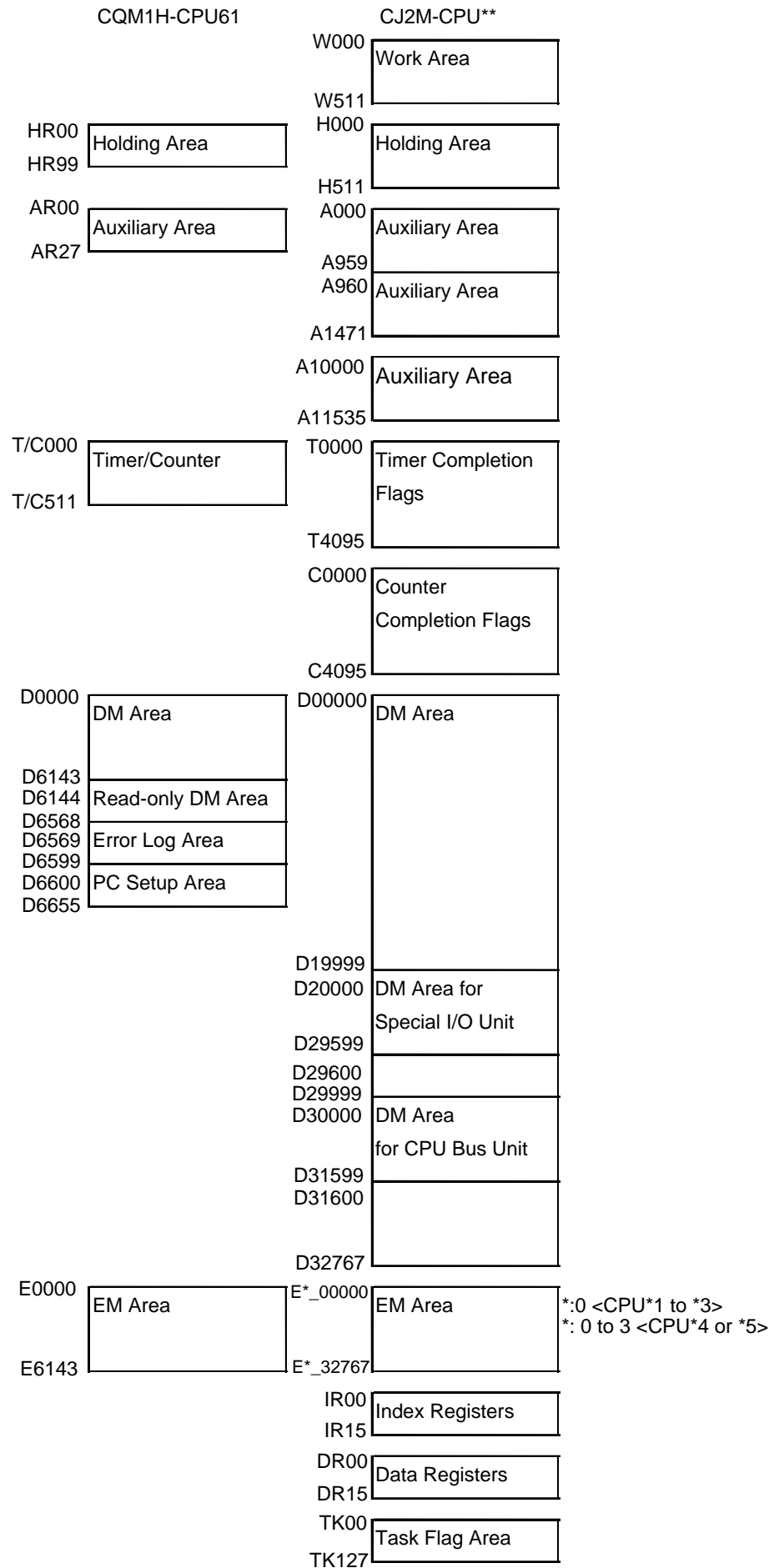

4. I/O Area Allocation

This section explains the difference of I/O area allocation in CQM1H, CJ2M series.

◆Unit Area Allocation for CQM1H

The I/O words are allocated to I/O Units and Dedicated I/O Units in the order of the unit mounting position from the left to right.

The input relays uses the area starting with IR000 (16 inputs on the CPU Unit always use IR000; other Input Units uses area starting with IR001). The output relays uses area starting with IR100.

Unit	Input relay	Output relay
16 inputs built into CPU Unit	Always allocated to IR 000.	-
Input Units or Dedicated I/O Units which uses input relay area	Allocated to the area starting with IR001. Allocation in the order of unit mounting position.	-
Output Units or Dedicated I/O Units which uses output relay area	-	Allocated to the area starting with IR100. Allocation in the order of unit mounting position.

◆ Unit Area Allocation for CJ2M

There are three unit types. The unit area allocation method is different in each group.

Unit	Allocation	Notes
Basic I/O Unit	0000 to 0159CH Allocated in the unit of 16 inputs/outputs based on the actually connected unit position	Same allocation as the CQM1H can be made if you set the starting address for the units. (Note1)
Special I/O Unit	2000 to 2959CH Uses 10 words for each unit. Allocated according to the Unit No.	-
CPU Bus Unit	1500 to 1899CH Uses 25 words for each unit. Allocated according to the Unit No	-

When I/O Area is used in the ladder program, change the CIO area and bit address using the “Change All” or “Replace” functions of CX-Programmer.

Note1: Unit area allocation same as CQM1H can be configured for CJ2M system, by setting the start address for each unit using CX-Programmer Ver.9.1 or later (For some systems, same allocation can not be made). It will reduce CIO area used for Basic I/O Units which must be changed, thus reducing work hour for modifying ladder program.

CQM1H

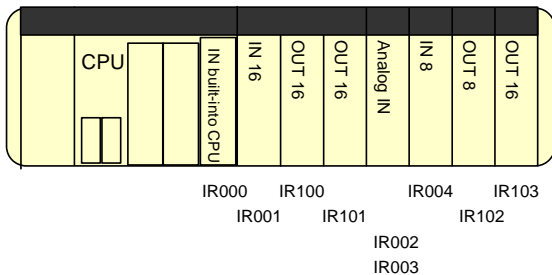

CJ2M

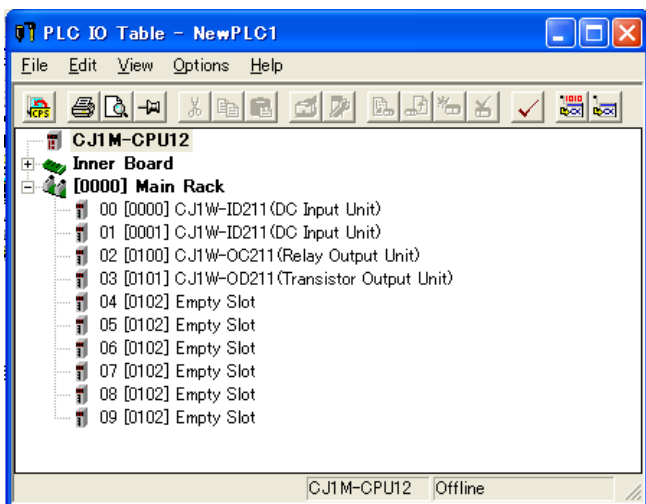
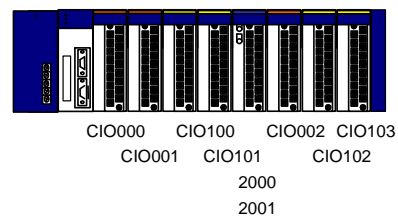

Slot start address changed on the CX-Programmer.

5. Instructions

The instruction specification is different in CQM1H series and CJ2M series.

The Appendix explains the difference in operand and flags. Refer to the Appendix for details.

- A-1 Instruction operations

Explains difference in instructions and operand. Least necessary adjustment after program conversion on the CX-Programmer.

- A-2 Condition flag operations

Explains difference concerning the operation of condition flags at each instruction execution.

5.1 High-speed counter/pulse output instruction

This section describes the difference of High-speed counter/pulse output instruction and explains the difference of pulse functions in CQM1H-PLB21 and CJ2M-CPU**

◆MODE CONTROL (INI)

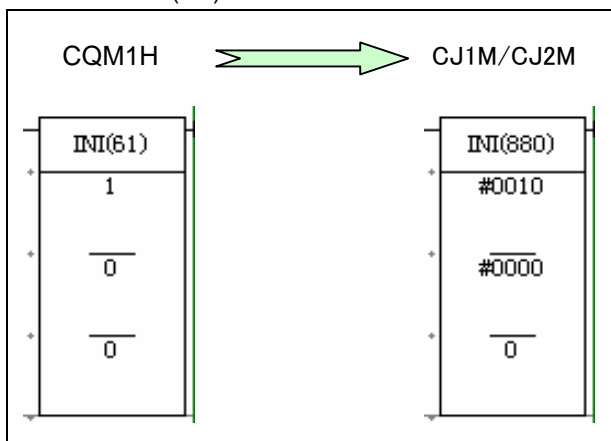

	CQM1H	CJ2M
Operand1	Port specifier: 001= PLB High-speed counter 1 002= PLB High-speed counter 2 001= PLB Pulse output 1 002= PLB Pulse output 2	Port specifier: #0010= High-speed counter 0 #0011= High-speed counter 1 #0012= High-speed counter 2 (CJ2M only) #0013= High-speed counter 3 (CJ2M only) #0000= Pulse output 0 #0001= Pulse output 1 #0002= Pulse output 2 (CJ2M only) #0003= Pulse output 3 (CJ2M only)
Operand2	Control data: 000= Starts comparison. 001= Stops comparison. 002= Changes high-speed counter PV. 003= Stops pulse output.	Control data: #0000= Starts comparison. #0001= Stops comparison. #0002= Changes the PV. #0003= Stops pulse output. #0006= Changes the maximum value of the ring counter (CJ2M only) #0005= Changes origin search/return settings(CJ2M only)

Operand3	<p>First PV word: (Only when Operand 2=002.) PLB High-speed counter 1, or 2, Linear counting mode = F8388608 to 08388607</p> <p>PLB High-speed counter 1, or 2, Ring counting mode = 00000000 to 00064999</p>	<p>First word with new PV: (Only when Operand 2=002.) High-speed counter input 0 or 1, Linear mode (increment/decrement pulses) High-speed counter input 2 or 3, Linear mode (increment/decrement pulses) <CJ2M only> = 80000000Hex to 7FFFFFFFHex</p> <p>High-speed counter input 0 or 1, Linear mode (increment pulses) High-speed counter input 2 or 3, Linear mode (increment pulses) <CJ2M only> = 00000000Hex to FFFFFFFFHex</p> <p>High-speed counter input 0 or 1, Ring mode High-speed counter input 2 or 3, Ring mode <CJ2M only> = 00000000Hex to FFFFFFFFHex</p>
----------	---	--

◆ HIGH-SPEED COUNTER PV READ (PRV)

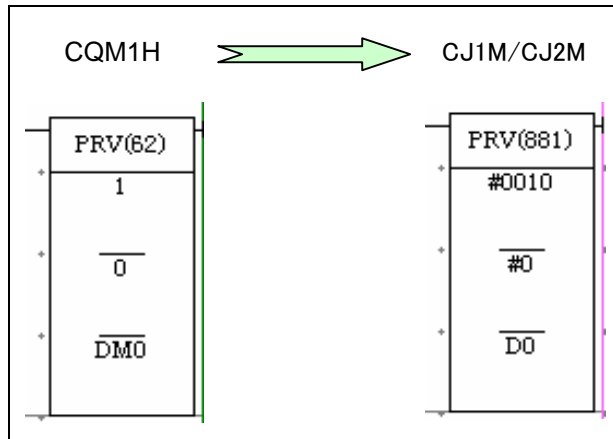

	CQM1H	CJ2M
Operand1	Port specifier: 001= PLB High-speed counter 1 002= PLB High-speed counter 2 001= PLB Pulse output 1 002= PLB Pulse output 2	Port specifier: #0010= High-speed counter input 0 #0011= High-speed counter input 1 #0012= High-speed counter input 2 (CJ2M only) #0013= High-speed counter input 3 (CJ2M only) #0000= Pulse output 0 #0001= Pulse output 1 #0002= Pulse output 2 (CJ2M only) #0003= Pulse output 3 (CJ2M only)
Operand2	Control data: 000= High-speed counter PV 001= Status of high-speed counter or pulse output 002= Range comparison results	Control data: #0000= Reads the PV. #0001= Reads status. #0002= Reads range comparison results #00*3= Reads the frequency of high-speed counter.

Operand3	<p>First destination word: When Operand 2=000 PLB High-speed counter 1 or 2, Linear counting mode: F8388608 to 08388607 PLB High-speed counter 1 or 2, Ring counting mode: 00000000 to 00064999</p> <p>When Operand 2 =001 PLB High-speed counter 1 or 2/ Pulse output 1, or 2: D7:Pulse output status D6: Pulse output completed D5: Total number of pulse specified D4:Deceleration of pulse frequency D1:Hihg-speed counter underflow/ overflow D0:High-speed counter comparison status</p> <p>When Operand 2=002 PLB High-speed counter 1 or 2 D7:Comparison Result flags for range 8 D6: Comparison Result flags for range 7 D0:Comparison Result flags for range 1</p>	<p>First destination word: When Operand 2=#0000 High-speed counter 0 or 1, Linear mode, (Not for incremental pulse input) High-speed counter 2 or 3, Linear mode, (Not for incremental pulse input) <CJ2M only> = 80000000Hex to 7FFFFFFFHex</p> <p>High-speed counter 0 or 1, Ring mode, Linear mode (For incremental pulse input) High-speed counter 2 or 3, Ring mode, Linear mode (For incremental pulse input) <CJ2M only> = 00000000Hex to FFFFFFFFHex</p> <p>When Operand 2 =#0001. High-speed counter 0, 1 High-speed counter 2, 3 (CJ2M only) D2: Count direction D1: PV Overflow/Underflow Flag D0: Comparison In-progress Flag Pulse output 0, 1 Pulse output 2, 3 (CJ2M only) D9: Interrupt input for interrupt feeding Error Flag D8: Interrupt Feeding In-progress Flag D7: Pulse Output Stopped Error Flag D6: At-origin Flag D5: No-origin Flag D4: Pulse Output In-progress Flag D3: Pulse Output Completed Flag D2: Pulse Output Amount Set Flag D1: PV Overflow/Underflow Flag D0: Pulse Output Status Flag</p> <p>When Operand2=#0002 High-speed counter 0 or 1, High-speed counter 2 or 3 <CJ2M only> [Results for 8 Ranges] D7: Comparison result 8 D6: Comparison result 7 to D0: Comparison result 1 [Results for 32 Ranges] <CJ2M only> (D+1) D15: Comparison result 32 D14: Comparison result 31 to D0: Comparison result 17 (D) D15: Comparison result 16 D14: Comparison result 15 to D0: Comparison result 1</p>
----------	--	---

◆ REGISTER COMPARISON TABLE (CTBL)

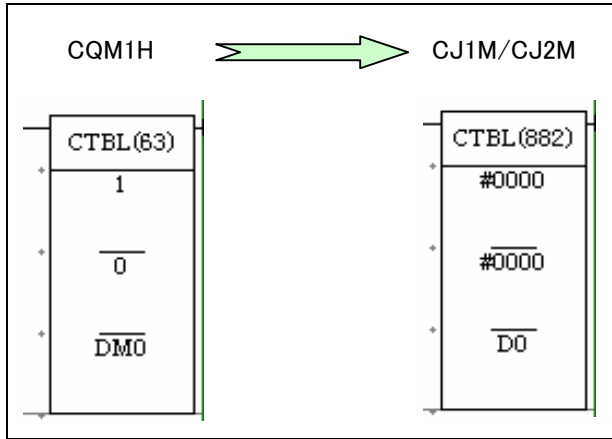

	CQM1H	CJ2M
Operand1	Port specifier: 001= PLB High-speed counter 1 002= PLB High-speed counter 2	Port specifier: #0000= High-speed counter input 0 #0001= High-speed counter input 1 #0002= High-speed counter input 2 (CJ2M only) #0003= High-speed counter input 3 (CJ2M only)
Operand2	Control Data (Mode): 000=Registers a target value comparison table and starts comparison. 001= Registers a range comparison table and starts comparison. 002= Registers a target value comparison table. 003= Registers range comparison table.	Control Data: #0000= Registers a target value comparison table and starts comparison #0001= Registers a range comparison table with 8 ranges and starts comparison. #0002= Registers a target value comparison table. #0003= Registers a range comparison table with 8 ranges, but does not perform comparison. #0004= Registers a range comparison table and starts comparison. (With 1 to 32 ranges (CJ2M only)) #0005= Registers a range comparison table, but does not perform comparison. (With 1 to 32 ranges (CJ2M only))
Operand3	First comparison table word: Refer to the following description for details.	First comparison table word: Refer to the following description for details.

<Target value comparison table>

Linear mode

CQM1H			→	CJ1M/CJ2M		
S	Number of target values	(BCD 4 digits) 0001 to 0048	S	Number of target values	(BIN 4 digits) 0001 to 0030Hex	
S+1	Target value #1, lower 4 digits	(BCD 8 digits)	S+1	Lower word of target value 1	(BIN 8 digits)	
S+2	Target value #1, upper 4digits	F8388608 to 08388607	S+2	Upper word of target value 1	80000000 to 7FFFFFFF	
S+3	Subroutine number	(Incremental) 0000 to 0255 (Decrement) F000 to F255	S+3	Interrupt task number for target value 1	(Incremental) 0000 to 00FF (Decrement) 8000 to 80FF	
S+142	Target value #48, lower 4 digits	(BCD 8 digits)	S+142	Lower word of target value 48	(BIN 8 digits)	
S+143	Target value #48, upper 4digits	F8388608 to 08388607	S+143	Upper word of target value 48	80000000 to 7FFFFFFF	
S+144	Subroutine number	(Incremental) 0000 to 0255 (Decrement) F000 to F255	S+144	Interrupt task number for target value 48	(Incremental) 0000 to 00FF (Decrement) 8000 to 80FF	

Ring mode

CQM1H			→	CJ1M/CJ2M		
S	Ring value, lower 4 digits	(BCD 8digits)	PLC Settings	Ring value: PLC Settings	((High-speed counter 0) CH51/52 ((High-speed counter 1) CH54/55)	
S+1	Ring value, upper 4 digits	00000000 to 00065000	S	Number of target values	(BIN 4 digits) 0001 to 0030Hex	
S+2	Number of target values	(BCD 4 digits) 0001 to 0048	S+1	Lower word of target value 1	(BIN 8 digits)	
S+3	Target value #1, lower 4digits	(BCD 8 digits)	S+2	Upper word of target value 1	80000000 to 7FFFFFFF	
S+4	Target value #1, upper 4digits	00000000 to 00064999	S+3	interrupt task number for target value 1	(Incremental) 0000 to 00FF (Decrement) 8000 to 80FF	
S+5	Subroutine number	(Incremental) 0000 to 0255 (Decrement) F000 to F255	S+142	Lower word of target value 48	(BIN 8 digits)	
S+144	Target value #48, lower 4digits	(BCD 8digits)	S+143	Upper word of target value 48	80000000 to 7FFFFFFF	
S+145	Target value #48, upper 4digits	00000000 to 00064999	S+144	Interrupt task number for target value 48	(Incremental) 0000 to 00FF (Decrement) 8000 to 80FF	
S+146	Subroutine number	(Incremental) 0000 to 0255 (Decrement) F000 to F255				

<Range comparison table> (Always contains 8 ranges)

Linear mode

CQM1H			→	CJ1M/CJ2M		
S	Lower limit #1, lower 4 digits	(BCD 8 digits)	S	Lower word of range 1 lower limit	(BIN8 digits)	
S+1	Lower limit #1, upper 4 digits	F8388608 to 08388607	S+1	Upper word of range 1 lower limit	80000000 to 7FFFFFFF	
S+2	Upper limit #1, lower 4 digits	(BCD 8 digits)	S+2	Lower word of range 1 upper limit	(BIN8 digits)	
S+3	Upper limit #1, upper 4 digits	F8388608 to 08388607	S+3	Upper word of range 1 upper limit	80000000 to 7FFFFFFF	
S+4	Subroutine number	(BCD 4 digits) 0000 to 0255 Disabled =FFFF	S+4	Range 1 interrupt task number	BIN 4 digits) 0000 to 00FF Do not execute interrupt task=AAAA Ignore the settings for this range.	
S+35	Lower limit #8, lower 4 digits	(BCD 8 digits)	S+35	Lower word of range 8 lower limit	(BIN8 digits)	
S+36	Lower limit #8, upper 4 digits	F8388608 to 08388607	S+36	Upper word of range 8 lower limit	80000000 to 7FFFFFFF	
S+37	Upper limit #8, lower 4 digits	(BCD 8 digits)	S+37	Lower word of range 8 upper limit	(BIN8 digits)	
S+38	Upper limit #8, upper 4 digits	F8388608 to 08388607	S+38	Upper word of range 8 upper limit	80000000 to 7FFFFFFF	
S+39	Subroutine number	(BCD 4 digits) 0000 to 0255 Disabled = FFFF	S+39	Range 8 interrupt task number	(BIN 4 digits) 0000 to 00FF Do not execute interrupt task=AAAA Ignore the settings for this range. =FFFF	

Ring mode

CQM1H			→	CJ1M/CJ2M		
S	Ring value, lower 4 digits	(BCD 8 digits)	PLC settings	Ring value:	((High-speed counter 0) CH51/52 ((High-speed counter 1) CH54/55)	
S+1	Ring value, upper 4 digits	00000000 to 00065000	PLC settings	PLC settings		
S+2	Lower limit #1, lower 4 digits	(BCD 8 digits)	S	Lower word of range 1 lower limit	(BIN 8 digits)	
S+3	Lower limit #1, upper 4 digits	00000000 to 00064999	S+1	Upper word of range 1 lower limit	00000000 to FFFFFFFF	
S+4	Upper limit #1, lower 4 digits	(BCD 8 digits)	S+2	Lower word of range 1 upper limit	(BIN 8 digits)	
S+5	Upper limit #1, upper 4 digits	00000000 to 00064999	S+3	Upper word of range 8 upper limit	00000000 to FFFFFFFF	
S+6	Subroutine number	(BCD 4 digits) 0000 to 0255 Disable =FFFF	S+4	Range 1 interrupt task number	BIN 4 digits) 0000 to 00FF Do not execute interrupt task=AAAA Ignore the settings for this range.	
S+37	Lower limit #8, lower 4 digits	(BCD 8 digits)	S+35	Lower word of range 8 lower limit	(BIN8 digits)	
S+38	Lower limit #8, upper 4 digits	00000000 to 00064999	S+36	Upper word of range 1 lower limit	00000000 to FFFFFFFF	
S+39	Upper limit #8, lower 4 digits	(BCD 8 digits)	S+37	Lower word of range 8 upper limit	(BIN8 digits)	
S+40	Upper limit #8, upper 4 digits	00000000 to 00064999	S+38	Upper word of range 8 upper limit	00000000 to FFFFFFFF	
S+41	Subroutine number	(BCD 4 digits) 0000 to 0255 Disable =FFFF	S+39	Range 8 interrupt task number	BIN 4 digits) 0000 to 00FF Do not execute interrupt task=AAAA Ignore the settings for this range.	

◆ SPEED OUTPUT (SPED)

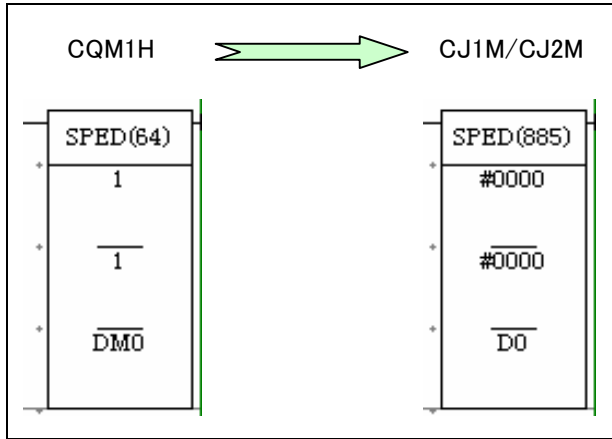

	CQM1H	CJ2M
Operand1	Port specifier: 001= PLB Pulse output 1 002= PLB Pulse output 2	Port specifier: #0000= Pulse output 0 #0001= Pulse output 1 #0002= Pulse output 2 (CJ2M only) #0003= Pulse output 3 (CJ2M only)
Operand2	Output mode: 000= Independent mode (Frequency set in units of 10Hz) 001= Continuous mode (Frequency set in units of 10Hz) 002= Independent mode (Frequency set in units of 1Hz) 003= Continuous mode (Frequency set in units of 1Hz)	Output mode: D15 to D12= Always 0 hex. D11 to D08= Pulse output method 0 hex.: CW/CCW 1 hex.: Pulse + direction D07 to D04= Direction 0 hex.:CW 1 hex.:CCW D03 to D00= Mode 0 hex.: Continuous 1 hex.: Independent
Operand3	Pulse Frequency: (When frequency is set in units of 10Hz.) 0001 to 5000 (When frequency is set in units of 1Hz.) 0010 to 9999	First pulse frequency word: 00000000 Hex to 000186A0 Hex

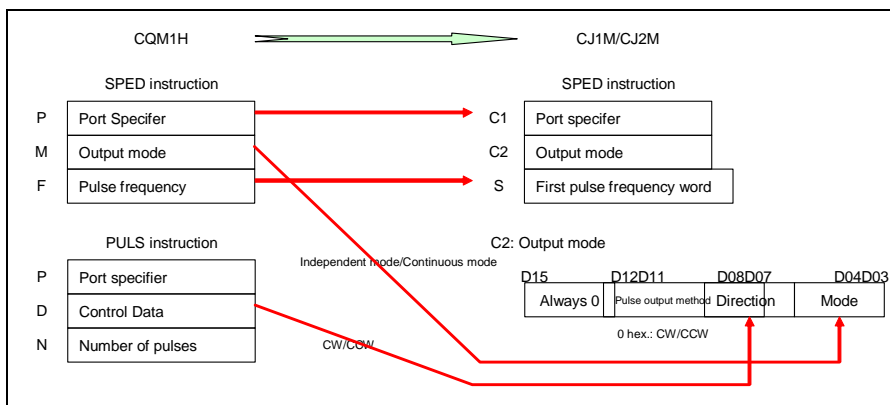

◆ SET PULSES (PULS)

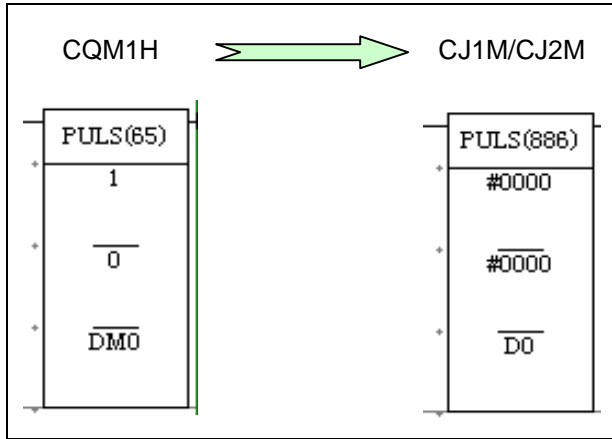

	CQM1H	CJ2M
Operand1	Port specifier: 001=PLB Pulse output 1 002=PLB Pulse output 2	Port specifier: #0000= Pulse output 0 #0001= Pulse output 1 #0002= Pulse output 2 (CJ2M only) #0003= Pulse output 3 (CJ2M only)
Operand2	Control Data: 000= CW direction (Number of pulses is set.) 001= CCW direction (Number of pulses is set.) 002= CW direction (Number of pulses and deceleration point are set.) 003= CCW direction (Number of pulses and deceleration point are set.) 004= CW direction (Number of pulses is not set.) 005= CCW direction (Number of pulses is not set.)	Pulse Type: #0000= Relative #0001=Absolute
Operand3	Number of pulses: 00000001 to 16777215	Number of pulses: (When relative pulse is selected.) 00000000Hex to 7FFFFFFF Hex (When absolute pulse is selected.) 80000000Hex to 7FFFFFFF Hex

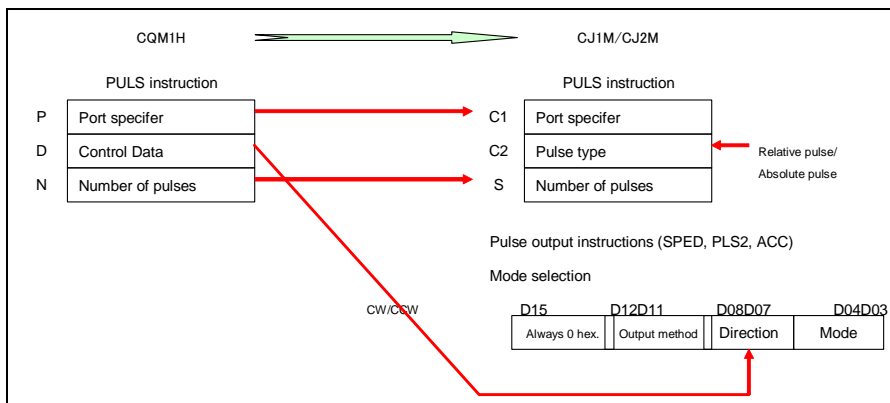

◆ ACCLERATION CONTROL (ACC)

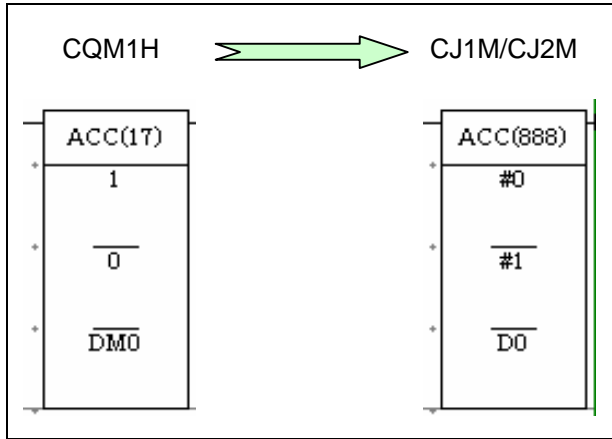

	CQM1H	CJ2M
Operand1	Communications port: 001= PLB Pulse output 1 002= PLB Pulse output 2	Port specifier: #0000= Pulse output 0 #0001= Pulse output 1 #0002= Pulse output 2 (CJ2M only) #0003= Pulse output 3 (CJ2M only)
Operand2	Mode specifier: 000=Mode0 (Acceleration + Independent mode) 001=Mode1 (Acceleration + Continuous mode) 002=Mode2 (Deceleration + Independent mode) 003= Mode3 (Deceleration + Continuous mode)	Output mode: D15 to D12= Operation compensation for parameterchanges 0 hex.: No operation compensation 4 hex.: Operation compensation D11 to D08= Pulse output method 0 hex.: CW/CCW 1 hex.: Pulse + direction D07 to D04= Direction 0 hex.:CW 1 hex.:CCW D03 to D00=Mode 0 hex.: Continuous mode 1 hex.: Independent mode
Operand3	First control word: [T] Acceleration/Deceleration rate = 0001 to 0200 [T+1] Target frequency =0000 to 5000 [T+2] Deceleration rate =0001 to 0200 [T+3] Frequency after deceleration = 0000 to 5000	First word of settings table: [S]Acceleration/Deceleration rate = 0001 to FFFF Hex [S+1] Lower word with target frequency [S+2]Upper word with target frequency 00000000 to 000186A0 hex.

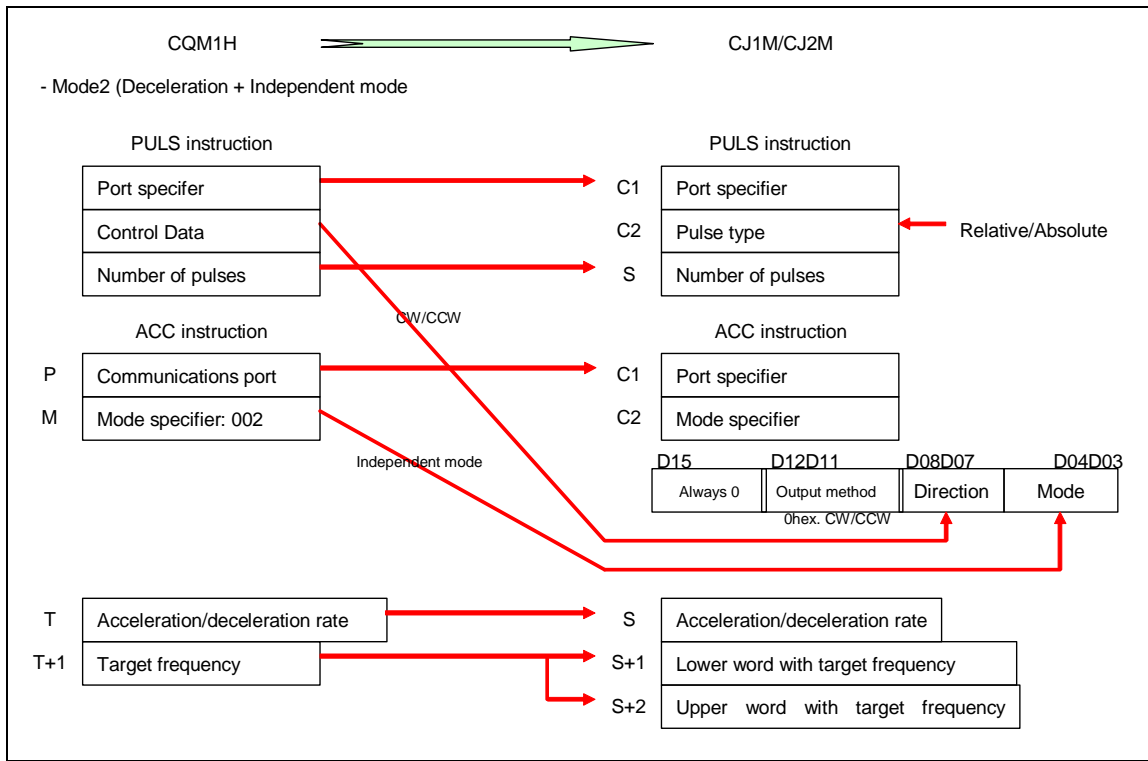

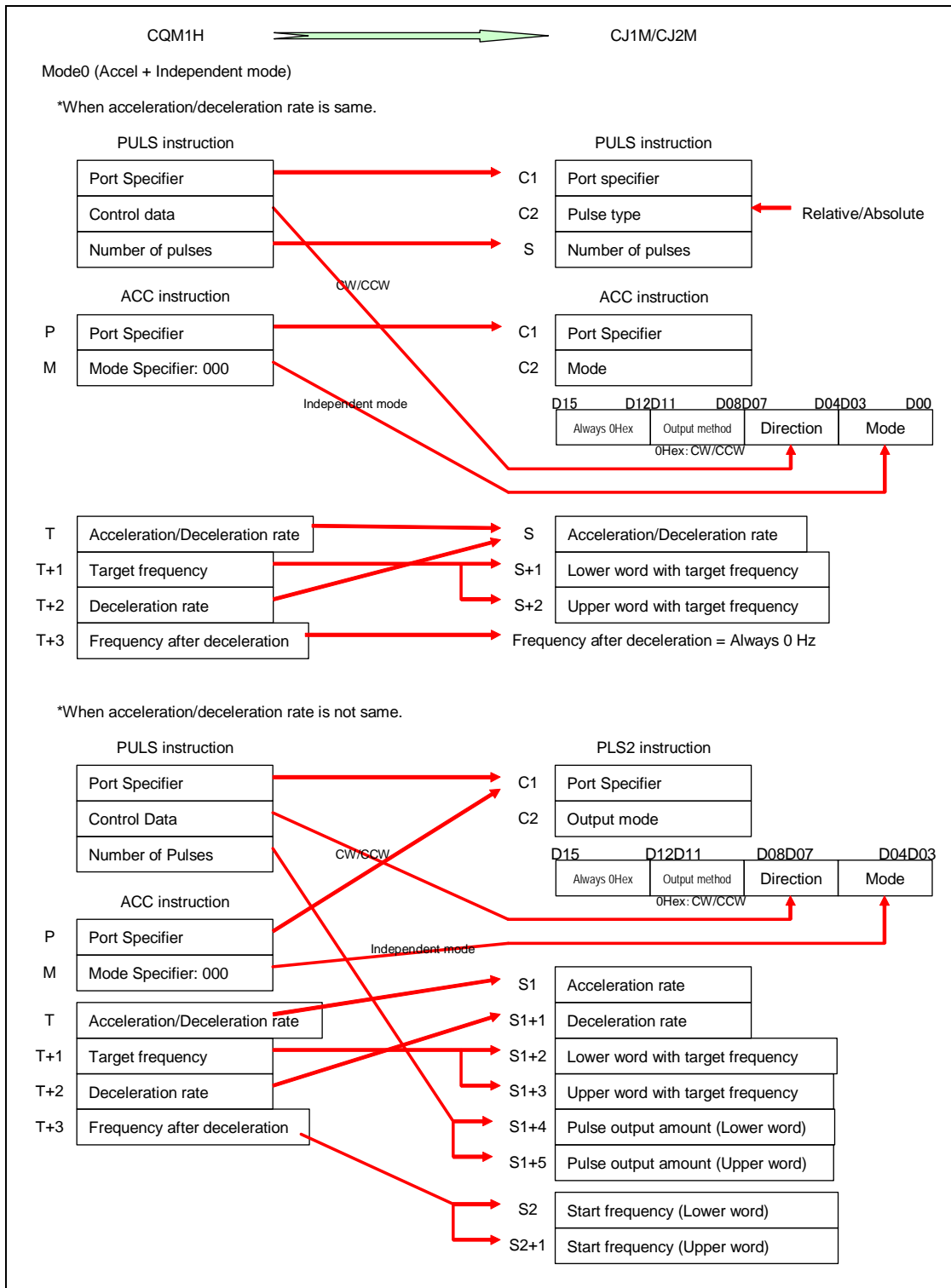

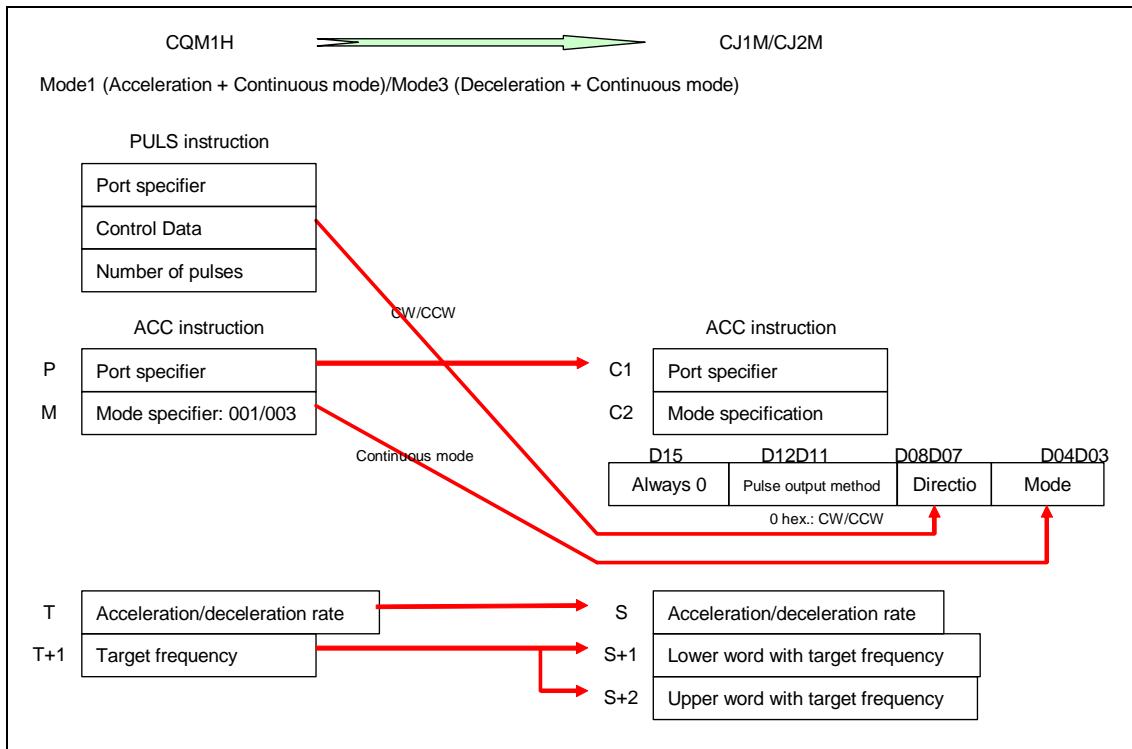

◆ PULSE OUTPUT (PLS2)

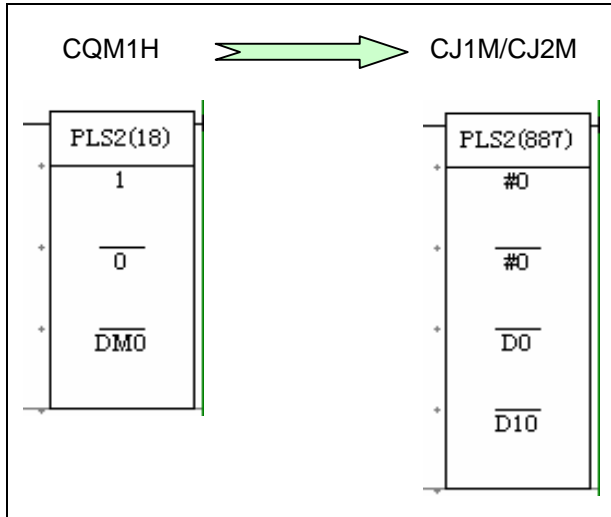

	CQM1H	CJ2M
Operand1	Communications port: 001= PLB Pulse output 1 002= PLB Pulse output 2	Port specifier: #0000= Pulse output 0 #0001= Pulse output 1 #0002= Pulse output 2 (CJ2M only). #0003= Pulse output 3 (CJ2M only)
Operand2	Direction specifier: 000= CW 001= CCW	Output mode: D15 to D12= Stopping operation for reversal specification/Operation compensation for parameters changes 0 Hex: Deceleration stop when reversing and no operation compensation 4 Hex: Deceleration stop when reversing and operation compensation 8 Hex: Immediate stop when reversing and no operation compensation C Hex: Immediate stop when reversing and operation compensation D11 to D08= Pulse output method 0 Hex: CW/CCW 1 Hex: Pulse + direction D07 to D04= Direction 0 Hex: CW 1 Hex: CCW D03 to D00= Relative/absolute specifier 0 Hex: Relative pulses 1 Hex: Absolute pulses
Operand3	First control word: [C] Acceleration rate = 0001 to 0200 [C+1] Target frequency = 0010 to 5000 [C+2] Lower word with number of pulses that will be output [C+3] Upper word with number of pulses that will be output 00000001 to 16777215	First word of settings table: [S1] Acceleration rate = 0001 to FFFF Hex [S1+1] Deceleration rate= 0001 to FFFF Hex [S1+2] Lower word with target frequency [S1+3] Upper word with target frequency 00000000 to 000186A0 Hex [S1+4] Lower word with number of output pulses [S1+5] Upper word with number of output pulses 00000000 to 7FFFFFFF Hex(Relative pulses) 80000000 to 7FFFFFFF Hex(Absolute pulses)
Operand4	-	First word of starting frequency: [S2] Lower word with starting frequency: 00000000 [S2+1] Upper word with starting frequency: 000186A0Hex max.

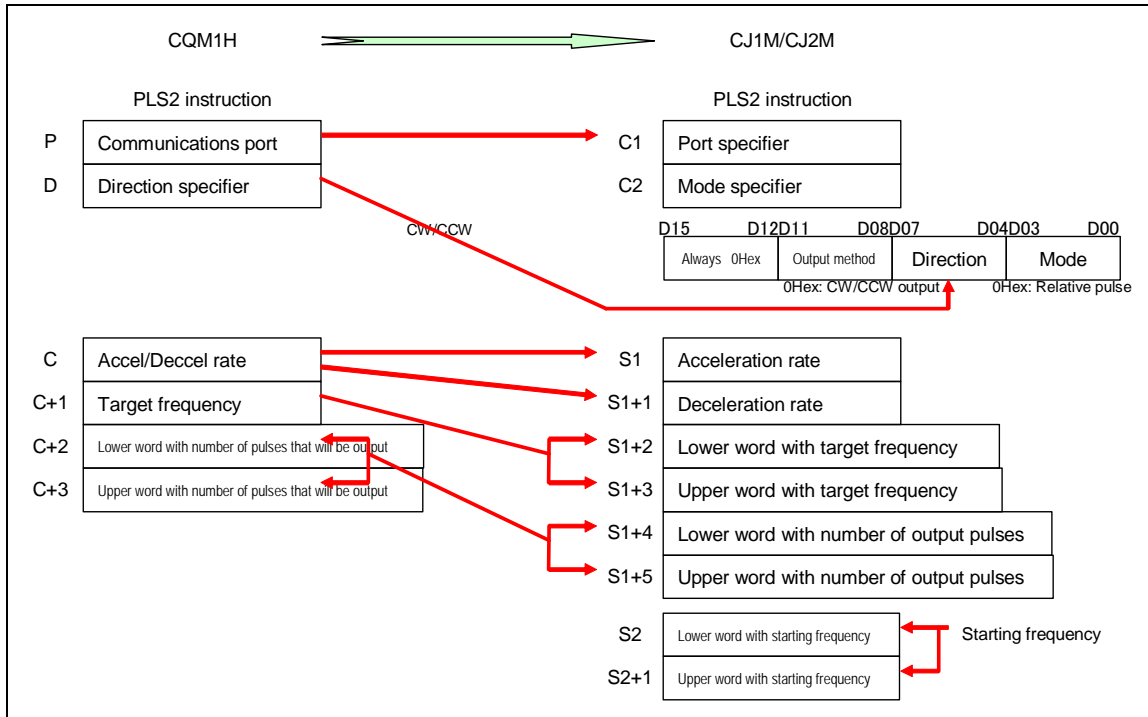

◆ PULSE WITH VARIABLE DUTY FACTOR (PWM)

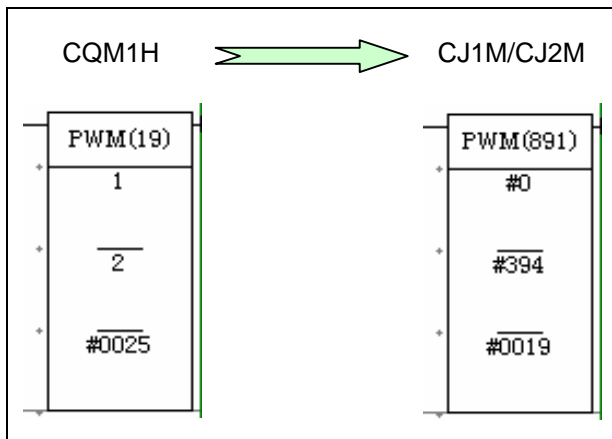

	CQM1H	CJ2M
Operand 1	<p>Communications Port:</p> <p>001=PLB Pulse Output1</p> <p>002=PLB Pulse Output 2</p>	<p>Port specifier:</p> <p>#0000= PWM output 0 (Frequency unit of 0.1Hz, Duty factor unit of 1%)</p> <p>#0001=PWM output 1(Frequency unit of 0.1Hz, Duty factor unit of 1%)</p> <p>#0002=PWM output 2(Frequency unit of 0.1Hz, Duty factor unit of 1%)</p> <p>#0003=PWM output 3(Frequency unit of 0.1Hz, Duty factor unit of 1%)</p> <p>#1000=PWM output 0 (Frequency unit of 0.1Hz, Duty factor unit of 0.1%)</p> <p>#1001=PWM output1 (Frequency unit of 0.1Hz, Duty factor unit of 0.1%)</p> <p>#1002=PWM output2 (Frequency unit of 0.1Hz, Duty factor unit of 0.1%)</p> <p>#1003=PWM output 3(Frequency unit of 0.1Hz, Duty factor unit of 0.1%)</p> <p>#1100=PWM output 0 (Frequency unit of 1Hz, Duty factor unit of 0.1%)</p> <p>#1101=PWM output 1 (Frequency unit of 1Hz, Duty factor unit of 0.1%)</p> <p>#1102=PWM output 2 (Frequency unit of 1Hz, Duty factor unit of 0.1%)</p> <p>#1103=PWM output 3 (Frequency unit of 1Hz, Duty factor unit of 0.1%)</p>
Operand 2	<p>Frequency:</p> <p>000= 5.9kHz</p> <p>001= 1.5kHz</p> <p>002= 91.6Hz</p>	<p>Frequency:</p> <p>0001 to FFFFHex (0.1Hz to 6553.5Hz, Frequency unit of 0.1Hz)</p> <p>0001 to 8020Hex (1Hz to 32800Hz, Frequency unit of 1Hz)</p> <p>* The ccuracy of PWM wave guaranteed is limited to the range between 0.1 to 1000.0Hz, due to limitation of output circuit.</p> <p>Output accuracy: ON duty +2%, -0% (With 1kHz, 0.5mA output)</p> <p>* The ccuracy of PWM wave guaranteed is limited to the range between 0.1 to 1000.0Hz, due to limitation of output circuit.</p> <p>Output accuracy: ON duty +5%, -0% (With 1kHz 0.5mA output)</p>
Operand 3	<p>Duty factor:</p> <p>0001 to 0099 (1 to 99%)</p>	<p>Duty factor:</p> <p>0000 to 0064Hex (0 to 100%)</p> <p>0000 to 03E8Hex (0 to 100%)</p>

5.2 I/O instructions

I/O instructions corresponds to the convenient instructions of CQM1H have been added for CJ2M CPU Unit. A part of specifications of those instructions are different; refer to the table below for details of difference in Operands. The execution time of each instruction is also different; be sure to check the operation for system safety.

◆DIGITAL SWITCH INPUT (DSW)

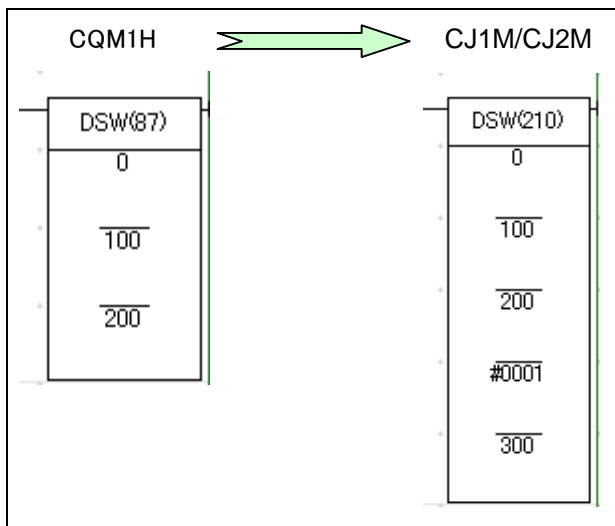

	CQM1H	CJ2M
Operand1	Input word: D7 to D4:Leftmost 4 digits D3 to D0:Rightmost 4 digits	Input word (Data line inputs(D0 to D3)) D7 to D4: Rightmost 4 digits D3 to D0:Leftmost 4 digits
Operand2	Output word: D5: One round flag D4:RD (read) signal (RD0) D3 to D0:CS signal (CS3 to CS0)	Output word (CS/RD control signal outputs) D5: One round flag D4: RD0 Read signal D3 to D0:CS signals (CS3 to CS0)
Operand3	First register word: [R1]: Least significant digits (4 digits) [R1+1]:Most significant digits (4 digits)	First Result Word: D15 to D12: Digit 4 D11 to D08: Digit 3 D07 to D04: Digit 2 D03 to D00: Digit 1
Operand4	-	Number of digits: [C]#0000: 4 digits #0001: 8 digits [C+1] System word

Other information

	CQM1H	CJ2M
Limitations in number of time used.	Once in one program	No limitations
Settings for Number of digits	Set in PC Setup DM6639. 00 (Default) :4 digits, 01: 8 digits	Set in Operand 4.
ER flag operation	- Content of *DM/*EM word is not BCD, or the Em/DM area boundary has been exceeded. (EM can be used with CQM1H-CPU61 only.) - R and R+1 are not in the same data area. (When the CQM1H is set to receive 8-digit data.) - Other than above, ER flag is OFF.	OFF (ER flag does not turn ON with left errors, since they are handled as Illegal access error).
Fun No.	87(Expansion instructions)	210

◆TEN KEY INPUT (TKY)

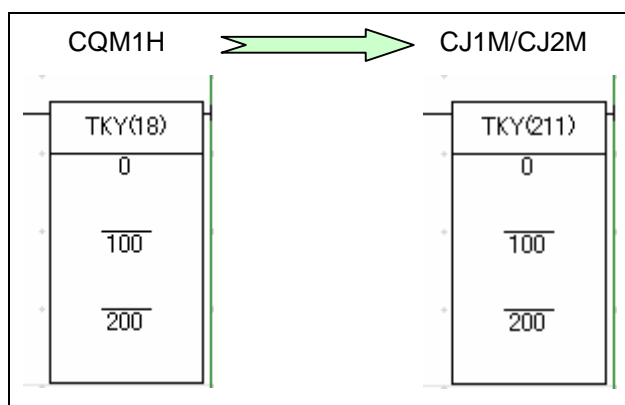

	CQM1H	CJ2M
Operand1	Input word: D09 to D00: Bit00 to 09 works as ten keys (0 to 9).	Input word (Data line inputs): D09 to D00: Bit00 to 09 works as ten keys (0 to 9).
Operand2	First register word: [D1]: Least significant 4 digits [D1+1]: Most significant 4 digits	First register word : [D1]D15 to D12: Digit 4 D11 to D08: Digit 3 D07 to D04: Digit 2 D03 to D00: Digit 1 [D1+1]D15 to D12: Digit 8 D11 to D08: Digit 7 D07 to D04: Digit 6 D03 to D00: Digit 5
Operand3	Key input word: D10: ON when any key is pressed. D09 to D00: ON when the corresponding key is pressed. (Remains on until another key is pressed.)	Key input word: D10: ON when any key is pressed. D09 to D00: ON when the corresponding key is pressed. (Remains on until another key is pressed.)

Other information

	CQM1H	CJ2M
Limitations in number of time used.	Can be used twice or more times; however, input word address must be changed.	None
ER flag operation	- Content of *DM/*EM word is not BCD, or the Em/DM area boundary has been exceeded. (EM can be used with CQM1H-CPU61 only.) - D and D+1 are not in the same data area. - Other than above, ER flag is OFF.	OFF (ER flag does not turn ON with left errors, since they are handled as Illegal access error).
Fun No.	18 (Expansion instructions)	211

◆HEXADECIMAL KEY INPUT (HKY)

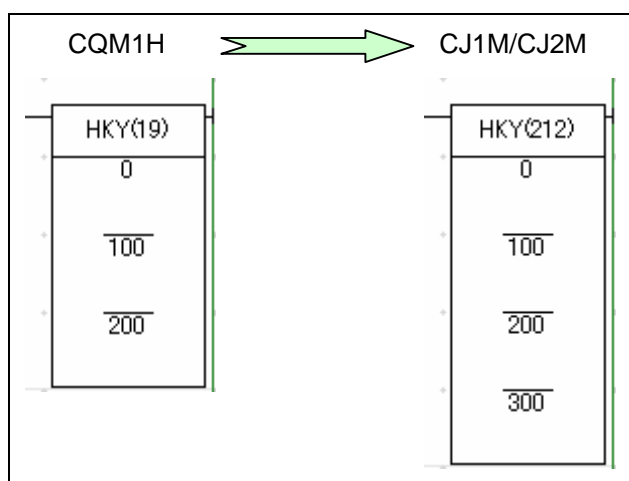

	CQM1H	CJ2M
Operand 1	Input word:	Input word (Data line D0 to D3 inputs): D03 to D00: Bits 00 to 03 correspond to Input Unit inputs 0 to 3.
Operand 2	Control signal output word: D03 to D00:16 key selection control signal	Output word (Selection signal output): D03 to D00: Bits 00 to 03 correspond to Output Unit outputs 0 to 3.
Operand 3	First register word: [D1]: Least significant 4 digits [D1+1]: Most significant 4 digits [D1+2]: ON when the corresponding key is pressed. (Remains on until another key is pressed.)	First register word: [D1]D15 to D12: Digit 4 D11 to D08: Digit 3 D07 to D04: Digit 2 D03 to D00:Digit 1 [D1+1]D15 to D12: Digit 8 D11 to D08: Digit 7 D07 to D04: Digit 6 D03 to D00: Digit 5 [D1+2]D15 to D00: ON when the corresponding key is pressed. (Remains on until another key is pressed.)
Operand 4	-	System word:

Other information

	CQM1H	CJ2M
Limitations in number of time used.	Once in one program	No limitations
ER flag operation	- Content of *DM/*EM word is not BCD, or the EM/DM area boundary has been exceeded. (EM can be used with CQM1H-CPU61 only.) - R and R+1 are not in the same data area. - Other than above, ER flag is OFF.	OFF (ER flag does not turn ON with left errors, since they are handled as Illegal access error).
Fun No.	--- (Expansion instruction)	212

◆7-SEGMENT DISPLAY OUTPUT (7SEG)

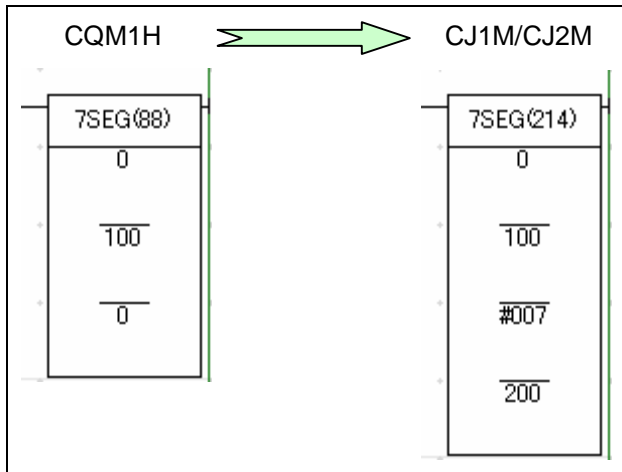

	CQM1H	CJ2M																																																												
Operand1	First source word: [S1]: Rightmost 4 digits [S1+1]: Leftmost 4 digits	Source word: [S1]D15 to D12: Digit 4 D11 to D08: Digit 3 D07 to D04: Digit 2 D03 to D00: Digit 1 [S1+1]D15 to D12: Digit 8 D11 to D08: Digit 7 D07 to D04: Digit 6 D03 to D00: Digit 5																																																												
Operand2	Output word: Converting 4 digits D08:One round flag D07 to D04: Latch output LE3 to LE0 D03 to D00: 4-digit data output Converting 8 digits D12: One round flag D11 to D08:Latch output LE3 to LE0 D07 to D04:Rightmost 4-digit data output D03 to D00: Leftmost 4-digit data output	Output word (Data and latch outputs): Converting 4 digits D08:One round flag D07 to D04: Latch output LE3 to LE0 D03 to D00: 4-digit data output Converting 8 digits D12: One round flag D11 to D08:Latch output LE3 to LE0 D07 to D04:Rightmost 4-digit data output D03 to D00: Leftmost 4-digit data output																																																												
Operand3	Control data: <table border="1"> <thead> <tr> <th>Data</th> <th>Source data</th> <th>Display's data Input logic</th> <th>Display's katch input logic</th> </tr> </thead> <tbody> <tr> <td>000</td> <td rowspan="3">4 digits (4 digits x 1)</td> <td rowspan="3">Same as Output Unit</td> <td>Same as Output Unit</td> </tr> <tr> <td>001</td> <td>Different from Output Unit</td> </tr> <tr> <td>002</td> <td>Same as Output Unit</td> </tr> <tr> <td>003</td> <td rowspan="4">8 digits (8 digit x 1)</td> <td rowspan="4">Different from Output Unit</td> <td>Different from Output Unit</td> </tr> <tr> <td>004</td> <td>Same as Output Unit</td> </tr> <tr> <td>005</td> <td>Different from Output Unit</td> </tr> <tr> <td>006</td> <td>Same as Output Unit</td> </tr> <tr> <td>007</td> <td rowspan="3">4 digits (4 digits x 1)</td> <td rowspan="3">Different from Output Unit</td> <td>Different from Output Unit</td> </tr> <tr> <td>002</td> <td>Same as Output Unit</td> </tr> <tr> <td>003</td> <td>Different from Output Unit</td> </tr> </tbody> </table>	Data	Source data	Display's data Input logic	Display's katch input logic	000	4 digits (4 digits x 1)	Same as Output Unit	Same as Output Unit	001	Different from Output Unit	002	Same as Output Unit	003	8 digits (8 digit x 1)	Different from Output Unit	Different from Output Unit	004	Same as Output Unit	005	Different from Output Unit	006	Same as Output Unit	007	4 digits (4 digits x 1)	Different from Output Unit	Different from Output Unit	002	Same as Output Unit	003	Different from Output Unit	Control data: <table border="1"> <thead> <tr> <th>Data</th> <th>Source data</th> <th>Display's data Input logic</th> <th>Display's katch input logic</th> </tr> </thead> <tbody> <tr> <td>000</td> <td rowspan="3">4 digits (4 digits x 1)</td> <td rowspan="3">Same as Output Unit</td> <td>Same as Output Unit</td> </tr> <tr> <td>001</td> <td>Different from Output Unit</td> </tr> <tr> <td>002</td> <td>Same as Output Unit</td> </tr> <tr> <td>003</td> <td rowspan="4">8 digits (4 digits x 2)</td> <td rowspan="4">Different from Output Unit</td> <td>Different from Output Unit</td> </tr> <tr> <td>004</td> <td>Same as Output Unit</td> </tr> <tr> <td>005</td> <td>Different from Output Unit</td> </tr> <tr> <td>006</td> <td>Same as Output Unit</td> </tr> <tr> <td>007</td> <td rowspan="3">4 digits (4 digits x 1)</td> <td rowspan="3">Different from Output Unit</td> <td>Different from Output Unit</td> </tr> <tr> <td>002</td> <td>Same as Output Unit</td> </tr> <tr> <td>003</td> <td>Different from Output Unit</td> </tr> </tbody> </table>	Data	Source data	Display's data Input logic	Display's katch input logic	000	4 digits (4 digits x 1)	Same as Output Unit	Same as Output Unit	001	Different from Output Unit	002	Same as Output Unit	003	8 digits (4 digits x 2)	Different from Output Unit	Different from Output Unit	004	Same as Output Unit	005	Different from Output Unit	006	Same as Output Unit	007	4 digits (4 digits x 1)	Different from Output Unit	Different from Output Unit	002	Same as Output Unit	003	Different from Output Unit
Data	Source data	Display's data Input logic	Display's katch input logic																																																											
000	4 digits (4 digits x 1)	Same as Output Unit	Same as Output Unit																																																											
001			Different from Output Unit																																																											
002			Same as Output Unit																																																											
003	8 digits (8 digit x 1)	Different from Output Unit	Different from Output Unit																																																											
004			Same as Output Unit																																																											
005			Different from Output Unit																																																											
006			Same as Output Unit																																																											
007	4 digits (4 digits x 1)	Different from Output Unit	Different from Output Unit																																																											
002			Same as Output Unit																																																											
003			Different from Output Unit																																																											
Data	Source data	Display's data Input logic	Display's katch input logic																																																											
000	4 digits (4 digits x 1)	Same as Output Unit	Same as Output Unit																																																											
001			Different from Output Unit																																																											
002			Same as Output Unit																																																											
003	8 digits (4 digits x 2)	Different from Output Unit	Different from Output Unit																																																											
004			Same as Output Unit																																																											
005			Different from Output Unit																																																											
006			Same as Output Unit																																																											
007	4 digits (4 digits x 1)	Different from Output Unit	Different from Output Unit																																																											
002			Same as Output Unit																																																											
003			Different from Output Unit																																																											
Operand4	-	System word:																																																												

Other information

	CQM1H	CJ2M
Limitations in number of time used.	Once in one program.	No limitations
ER flag operation	<ul style="list-style-type: none"> - Content of *DM/*EM word is not BCD, or the EM/DM area boundary has been exceeded. (EM can be used with CQM1H-CPU61 only.) - S and S+1 are not in the same data area. (When set to display 8-digit data.) - There is an error in operand settings - Other than above, ER flag is OFF. 	OFF (ER flag does not turn ON with left errors, since they are handled as Illegal access error).
Fun No.	88 (Expansion instruction)	214

5.3 Model conversion instructions

The model conversion instructions (below five instructions) which were added for CJ2M CPU Units in the same way as CQM1H series CPU Units.

Those instructions are automatically converted by executing change model (from CQM1H to CJ2M) on the CX-Programmer Ver.5 or later.

Be sure to check the operation, since operation specifications including instruction execution time might differ.

Instructions	Model conversion instruction (CJ2M CPU Units)	Corresponding instruction for CQM1H
BLOCK TRANSFER	XFERC (565)	XFER (70)
SINGLE WORD DISTRIBUTE	DISTC (566)	DIST (80)
hDATA COLLECT	COLLC (567)	COLL (81)
MOVE BIT	MOVBC (568)	MOVB (82)
BIT COUNTER	BCNTC (621)	BCNT (67)

6. Example of converting ladder program by CX-Programmer

This section explains the method of converting the ladder program using CX-Programmer V9.1. Here, convert the ladder program of CQM1H-CPU61 for CJ2M-CPU** as an example. (This section describes the procedure from loading the ladder program created by CX-Programmer or Sysmac Support Soft (SSS) to converting the program for CJ2M.)

After converting the ladder program, it is necessary to modify the unit area allocation, operand data, and condition flag settings, separately. Be sure to confirm the system safety before starting operation.

◆ Reading the ladder program of CQM1H

- SSS data

On the CX-Programmer, select File – Open. Set the file type to “SSS Ladder Program (*.SP1)” and open the SSS ladder program file for CQM1H. On the below dialog, Click the “Open”.

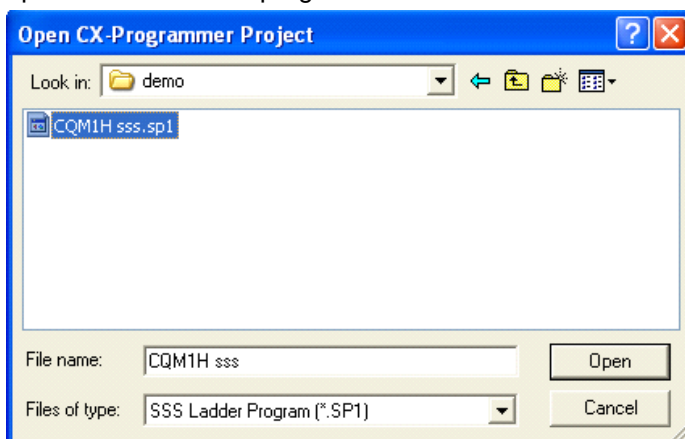

Then, dialog box to enter the model of CQM1 CPU Unit will be displayed. Enter the model of the CPU Unit. (For CQM1H, select corresponding CQM1 model.)

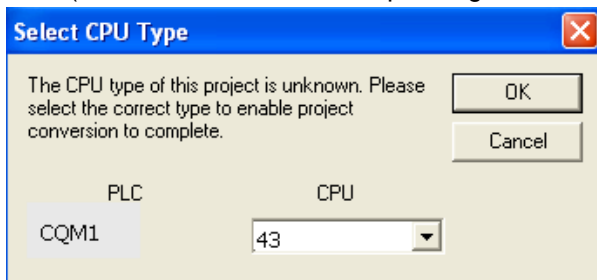

- CX-Programmer data

Click the "File" - "Open" and set the file type to CX-Programmer Project Files (*.cpx)". Then, open the ladder program file of CQM1H created on the CX-Programmer.

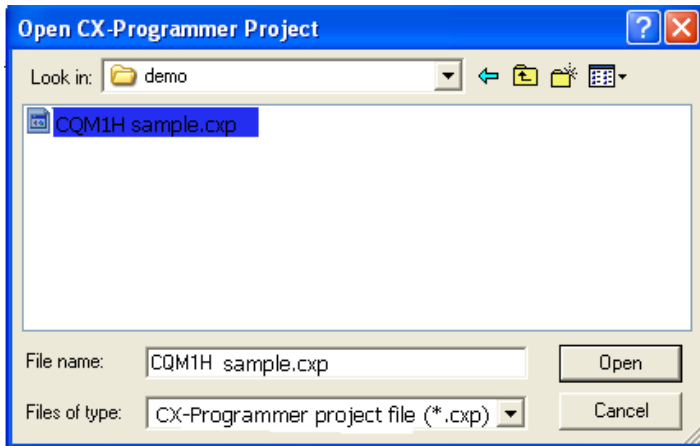

◆ Changing model from CQM1H to CJ2M.

As shown on the below figure, select NewPLC1[CQM1H] and right-click or double click it to change the PLC model. Please set the CPU model to the Device Type.

The error report might be displayed if there are instructions which cannot be converted.

Please correct and modify the program using support software function or manually, and execute program check. If errors are detected by the program check, please correct them referring to the error report.

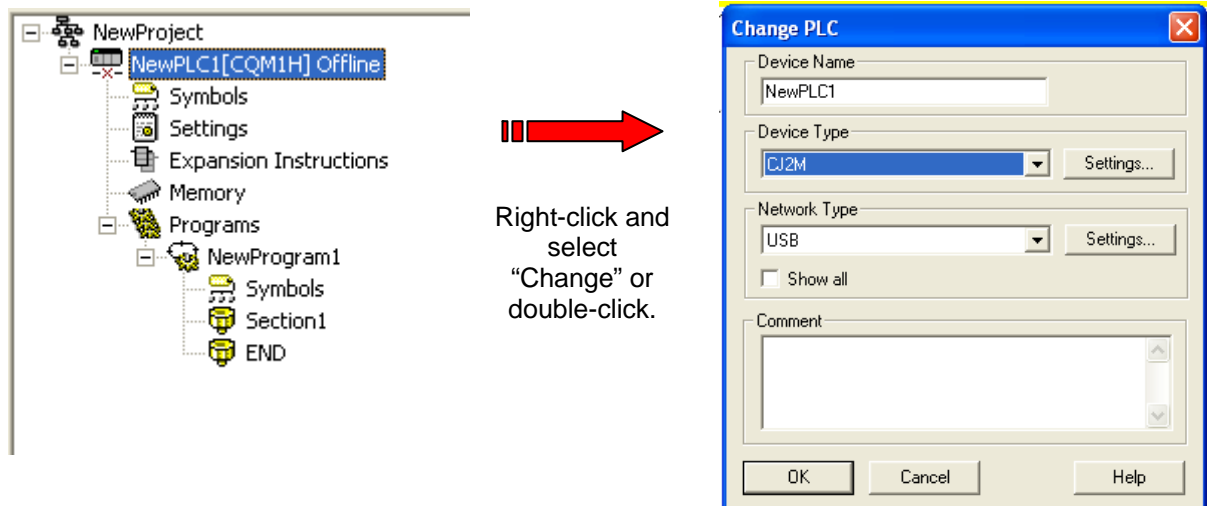

◆ Checking program

Check whether there is problem in the ladder program which was converted from the CQM1H series for CJ2M series.

■ Program check

There are 2 types of program check; automatic check on the CX-Programmer and check conducted by users. CX-Programmer checks the program when "Change model" is executed and the ladder program is converted.

- Automatic program check on the CX-Programmer

Timing of program check	Description
When PLC model is changed.	Program check for each PLC model Check for all instructions and all operands.

You can see the check result on the "Compile (Program check)" tab of the Output Window.

The left bus-bar on the ladder section window turns red if there is an error in the rung.

- Program check conducted by users

This section describes the procedure of program check, an example of checking result, and explanation of error levels.

<Program check for one program (task)>

1. Select the ladder section window or nimonic window to check.
2. Select "Program" – "Compile (Program check)".

The results of program check will be displayed on the Output Window. Refer to "Results of program check" on the next page for details.

- Checking the entire program
Select "PLC" – "Compile All PLC Programs".

You can see the program check results on the Output Window.
Refer to "Results of program check" for details.

<Results of program check>

You can see the check result on the "Compile (Program check)" tab of the Output Window.
There are three error levels; errors are divided and shown for each level.

When there is no error.

```

----- PLC: 'NewPLC1' (PLC Model 'CQM1H CPU11' to 'CJ2M CPU11') -----
Conversion issues...
[PLC/Program Name : Programs/NewProgram1]
[Ladder Section Name : Section1]
[Ladder Section Name : END]

NewPLC1 - 0 errors, 0 warnings.

```

When there are errors.

```

Compiling...
[PLC/Program Name : NewPLC1/NewProgram1]
[Ladder Section Name : Section1]
ERROR: Element at rung 0 (0, 0) is not connected at its output.
ERROR: Element at rung 0 (0, 1) is not connected at its output.
ERROR: Missing operand at rung 1 (1, 0).
ERROR: Missing operand at rung 1 (0, 0).
[Ladder Section Name : END]

NewProgram1 - 4 errors, 0 warnings.
The programs have been checked with the program check option set to Unit Ver.1.0.

```

Double-click an error on the Output Window to jump to the corresponding cell.

Numeric data in (,) shows the position of a cell with an error.

If you right-click on the Output Window, below menus are shown.

Menu	Functions
[Clear]	Clears the content of Output Window. Same as selecting "Edit" – "Clear Compile Window".
[Next Reference]	Jump to the error cell next to the error now selected. Same as selecting "Edit" – "Next Reference".
[Allow Docking]	Output Window is shown on the main window of the CX-Programmer. If uncheck the check box, Output Window will be shown on the separate window.
[Hide]	Close the output window. Same as selecting "View" – "Window" – "Output".
[Float In Main Window]	Output window will be changed to other window (ex. Ladder section window).

Conversion: **= Support software converts the instruction./-= Support software converts the instruction, but it is necessary to manually modify it. /- = There is no corresponding instruction.
 Blank cells: Support software converts the instructions, though there are some difference in CQM1H/CJ1M/CJ1G and CJ2M.

Instructions	CQM1H	CJ1M/CJ1G	Conversion	Difference between CQM1H and CJ1M/CJ1G/CJ2M (CQM1H->CJ1M/CJ1G/CJ2M)			BCD => BIN	Settings	Remarks
				Nemonic	FUN No.	Number of operand			
Sequence input instructions									
LOAD	LD	LD	**						
LOAD NOT	LD NOT	LD NOT	**						
AND	AND	AND	**						
AND NOT	AND NOT	AND NOT	**						
OR	OR	OR	**						
OR NOT	OR NOT	OR NOT	**						
AND LOAD	AND LD	AND LD	**						
OR LOAD	OR LD	OR LD	**						
Sequence output instructions									
OUTPUT	OUT	OUT	**						
OUTPUT NOT	OUT NOT	OUT NOT	**						
TR Bits	TR	TR	**						
KEEP	KEEP	KEEP	**						
DIFFERENTIATE UP	DIFU	DIFU	**						
DIFFERENTIATE DOWN	DIFD	DIFD	**						
SET	SET	SET	**						
RESET	RSET	RSET	**						
Sequence control instructions									
END	END	END	**						
NO OPERATION	NOP	NOP	**						
INTERLOCK	IL	IL	**						
INTERLOCK CLEAR	ILC	ILC	**						
JUMP	JMP	JMP	**				Jump No.		
JUMP END	JME	JME	**				Jump No.		
Timer and counter instructions									
TIMER	TIM	TIM	**						
HIGH-SPEED TIMER	TIMH	TIMH	**						
TOTALIZING TIMER	TTIM	TTIM	*		Expansion ->87				Operand3: reset input relay No will be deleted. Enter the reset input.
COUNTER	CNT	CNT	**						
REVERSIBLE COUNTER	CNTR	CNTR	**						
Comparison instructions									
COMPARE	CMP	CMP	**						
DOUBLE COMPARE	CMPL	CMPL	**		Expansion ->60	3 (None)->2			
SIGNED BINARY COMPARE	CPS	CPS	**		Expansion ->114	3 (None)->2			
DOUBLE SIGNED BINARY COMPARE	CPSL	CPSL	**		Expansion ->115	3 (None)->2			
MULTI-WORD COMPARE	MCMP	MCMP	**						
TABLE COMPARE	TCMP	TCMP	**						
BLOCK COMPARE	BCMP	BCMP	**						
AREA RANGE COMPARE	ZCP	ZCP	**		Expansion ->88				
DOUBLE AREA RANGE COMPARE	ZCPL	ZCPL	**		Expansion ->116				
Data movement instructions									
MOVE	MOV	MOV	**						
MOVE NOT	MVN	MVN	**						
MOVE BIT	MOV B	MOV B	*					Change bit position specification from in BCD to in BIN.	
		MOVBC	**		82->568				
		[Ver.3.0 or later]							
MOVE DIGIT	MOVD	MOVD	**						
TRANSFER BITS	XFRB	XFRB	**		Expansion ->62				
BLOCK TRANSFER	XFER	XFER	*					Number of words: BCD -> BIN	
		XFERC	**		70->565				
		[Ver.3.0 or later]							
BLOCK SET	BSET	BSET	**						
DATA EXCHANGE	XCHG	XCHG	**						
SINGLE WORD DISTRIBUTE	DIST	DIST	*					Stack length data set in words: BCD -> BIN	Use PUSH instruction instead, for stack operation.
		DISTC	**		80->566				
		[Ver.3.0 or later]							
DATA COLLECT	COLL	COLL	*					Stack length data set in words: BCD -> BIN	Use FIFO instruction instead, for stack operation and read FIFO. Use LIFO instruction instead, for stack operation and read LIFO.
		COLLC	**		81->567				
		[Ver.3.0 or later]							
Data shift instructions									
SHIFT REGISTER	SFT	SFT	**						
REVERSIBLE SHIFT REGISTER	SFTR	SFTR	**						
ASYNCHRONOUS SHIFT REGISTER	ASFT	ASFT	**						
WORD SHIFT	WSFT	WSFT	*			2->3			Set the shift data in the Operand 1.
ARITHMETIC SHIFT LEFT	ASL	ASL	**						
ARITHMETIC SHIFT RIGHT	ASR	ASR	**						
ROTATE LEFT	ROL	ROL	**						
ROTATE RIGHT	ROR	ROR	**						
ONE DIGIT SHIFT LEFT	SLD	SLD	**						
ONE DIGIT SHIFT RIGHT	SRD	SRD	**						
Increment/ decrement instructions									
INCREMENT	INC	++B	**	INC->++B	38->594				
BCD DECREMENT	DEC	--B	**	DEC->--B	39->596				
Symbol math instructions									
BINARY ADD	ADB	+C	**	ADB->+C	50->402				
DOUBLE BINARY ADD	ADBL	+CL	**	ADBL->+CL	Expansion ->403				
BCD ADD	ADD	+BC	**	ADD->+BC	30->406				
DOUBLE BCD ADD	ADDL	+BCL	**	ADDL->+BCL	54->407				
BINARY SUBTRACT	SBB	-C	**	SBB->-C	51->412				
DOUBLE BINARY SUBTRACT	SBBL	-CL	**	SBBL->-CL	Expansion ->413				
BCD SUBTRACT	SUB	-BC	**	SUB->-BC	31->416				
DOUBLE BCD SUBTRACT	SUBL	-BCL	**	SUBL->-BCL	55->417				
SIGNED BINARY MULTIPLY	MBS	*C	**	MBS->*C	Expansion ->420				
DOUBLE SIGNED BINARY MULTIPLY	MBSL	*L	**	MBSL->*L	Expansion ->421				
BINARY MULTIPLY	MLB	*U	**	MLB->*U	52->422				
BCD MULTIPLY	MUL	*B	**	MUL->*B	32->424				
DOUBLE BCD MULTIPLY	MULL	*BL	**	MULL->*BL	56->425				
SIGNED BINARY DIVIDE	DBS	/C	**	DBS->/C	Expansion ->430				
DOUBLE SIGNED BINARY DIVIDE	DBSL	/L	**	DBSL->/L	Expansion ->431				
BINARY DIVIDE	DVB	/U	**	DVB->/U	53->432				
BCD DIVIDE	DIV	/B	**	DIV->/B	33->434				
DOUBLE BCD DIVIDE	DIVL	/BL	**	DIVL->/BL	57->435				

Conversion: "*"= Support software converts the instruction./"= Support software converts the instruction, but it is necessary to manually modify it. /- = There is no corresponding instruction.
Blank cells: Support software converts the instructions, though there are some difference in CQM1H/CJ1M/CJ1G and CJ2M.

Instructions	CQM1H	CJ1M/CJ1G	Conversion	Difference between CQM1H and CJ1M/CJ1G/CJ2M (CQM1H->CJ1M/CJ1G/CJ2M)			Settings	Remarks
				Nemonic	FUN No.	Number of operand		
Conversion instructions								
BCD-TO-BINARY	BIN	BIN	**					
DOUBLE BCD-TO-DOUBLE BINARY	BINL	BINL	**					
BINARY-TO-BCD	BCD	BCD	**					
DOUBLE BINARY-TO-DOUBLE BCD	BCDL	BCDL	**					
2'S COMPLEMENT	NEG	NEG	**		Expansion ->160	3 (None)->2		
DOUBLE 2'S COMPLEMENT	NEGL	NEGL	**		Expansion ->161	3 (None)->2		
4-TO-16 DECODER	MLPX	MLPX	**					
16-TO-4 ENCODER	DMPX	DMPX	**					
ASCII CONVERT	ASC	ASC	**		Expansion ->162			
ASCII-TO-HEXADECIMAL	HEX	HEX	**		Expansion ->63		Bit number set in words: BCD -> BIN	
LINE	LINE	LINE	*				Bit number set in words: BCD -> BIN	
LINE TO COLUMN	COLM	COLM	*		Expansion ->64			
Logic instructions								
LOGICAL AND	ANDW	ANDW	**					
LOGICAL OR	ORW	ORW	**					
EXCLUSIVE OR	XORW	XORW	**					
EXCLUSIVE NOR	XNRW	XNRW	**					
COMPLEMENT	COM	COM	**					
Special math instructions								
BSQUARE ROOT	ROOT	ROOT	**					
ARITHMETIC PROCESS	APR	APR	*		Expansion ->69			
BIT COUNTER	BCNT	BCNT	*				Number of words set in words: BCD -> BIN	
		BCNTC [Ver.3.0 or later]	**		67->621			
Floating point math instructions								
FLOATING TO 16-BIT	FIX	FIX	**		Expansion ->450	3 (None)->2		
FLOATING TO 32-BIT	FIXL	FIXL	**		Expansion ->451	3 (None)->2		
16-BIT TO FLOATING	FLT	FLT	**		Expansion ->452	3 (None)->2		
32-BIT TO FLOATING	FLTL	FLTL	**		Expansion ->453	3 (None)->2		
FLOATING-POINT ADD	+F	+F	**		Expansion ->454			
FLOATING-POINT SUBTRACT	-F	-F	**		Expansion ->455			
FLOATING-POINT MULTIPLY	*F	*F	**		Expansion ->456			
FLOATING-POINT DIVIDE	/F	/F	**		Expansion ->457			
DEGREES TO RADIAN	RAD	RAD	**		Expansion ->458	3 (None)->2		
RADIANS TO DEGREES	DEG	DEG	**		Expansion ->459	3 (None)->2		
SINE	SIN	SIN	**		Expansion ->460	3 (None)->2		
COSINE	COS	COS	**		Expansion ->461	3 (None)->2		
TANGENT	TAN	TAN	**		Expansion ->462	3 (None)->2		
ARC SINE	ASIN	ASIN	**		Expansion ->463	3 (None)->2		
ARC COSINE	ACOS	ACOS	**		Expansion ->464	3 (None)->2		
ARC TANGENT	ATAN	ATAN	**		Expansion ->465	3 (None)->2		
SQUARE ROOT	SQRT	SQRT	**		Expansion ->466	3 (None)->2		
EXPONENT	EXP	EXP	**		Expansion ->467	3 (None)->2		
LOGARITHM	LOG	LOG	**		Expansion ->468	3 (None)->2		
Table data processing instructions								
DATA SEARCH	SRCH	SRCH	*		Expansion ->181		Number of words set in words: BCD -> BIN	Output selection to enable or disable the Outputs number of matches.
FIND MAXIMUM	MAX	MAX	*		Expansion ->182		Number of words in range: BCD -> BIN, Settings 12 bits -> 15 bits	Operand1: 1 word -> 2 words Comparison data, result word: C+1 -> Control data: 1word -> 2 word Output address: D+1 -> IR00
FIND MINIMUM	MIN	MIN	*		Expansion ->183		Number of words in range: BCD -> BIN, Settings 12 bits -> 15 bits	Select signed or unsigned/Outputs address to IR or not.
SUM	SUM	SUM	*		Expansion ->184		table length: BCD -> BIN, Settings 12 bits -> 15 bits	Select signed or unsigned/Outputs address to IR or not.
FCS CALCULATE	FCS	FCS	*		Expansion ->180		table length: BCD -> BIN, Settings 12 bits -> 15 bits	Set the Starting byte/Units/Data type/signed or not in C+1. Set the Starting byte/Units in C+1.
Data control instructions								
PID CONTROL	PID	PID	*		Expansion ->190		Set value: BCD -> BIN	Output selection to enable or disable the Outputs number of matches.
SCALING	SCL	SCL	*		66->194			Check setting items and set value.
SIGNED BINARY TO BCD SCALING	SCL2	SCL2	**		Expansion ->486			PID parameter area: 33ch -> 39ch
BCD TO SIGNED BINARY SCALING	SCL3	SCL3	**		Expansion ->487			Acaled value: variable accepted -> variable not accepted
AVERAGE VALUE	AVG	AVG	*		Expansion ->195		Number of cycles set in words: BCD -> BIN	Average Valid Flag: None -> Processing information D15 bit
Subroutines instructions								
SUBROUTINE ENTRY	SBS	SBS	**					
MACRO	MCRO	MCRO	**					Macro area input words: 96 to 99 -> A600 to A603, 196 to 199 -> A604 to A607 (No influence on the ladder program).
SUBROUTINE DEFINE	SBN	SBN	**					
SUBROUTINE RETURN	RET	RET	**					
Interrupt control instructions								
INTERRUPT CONTROL	INT	MSKS MSKR CLI DI EI	*	INT000->MSKS INT001->CLI INT002->MSKR INT003->MSKS/INI (CJ1M built-in input only) INT100->DI INT200->EI	89->690 89->691 89->692 89->690/880 89->693 89->694		Interrupt unit/CJ1M built-in interrupt input: newly configure the settings.	Interrupt program: interrupt subroutine -> interrupt task (Also change the number again).
INTERVAL TIMER	STIM	MSKS MSKR	(Partly "-" Instruction will not be converted if timer start/stop time is specified.	STIM003 to 005->MSKS STIM006 to 008->MSKR	69->690 69->692	Set the operands in BCD ->BIN.	Newly configure the settings again.	One-shot interrupt start: None Stopping timer function: None Set the unit of 0.1ms in PLC settings. Interrupt program: interrupt subroutine -> interrupt task (Newly set the task No.)
Step instructions								
STEP DEFINE	STEP	STEP	**					
STEP START	SNXT	SNXT	**					

Conversion: * = Support software converts the instruction. / = Support software converts the instruction, but it is necessary to manually modify it. - = There is no corresponding instruction.
Blank cells: Support software converts the instructions, though there are some difference in CQM1H/CJ1M/CJ1G and CJ2M.

Instructions	CQM1H	CJ1M/CJ1G	Conversion	Difference between CQM1H and CJ1M/CJ1G/CJ2M (CQM1H->CJ1M/CJ1G/CJ2M)			Settings	Remarks	
				Nemonic	FUN No.	Number of operand			
Basic I/O Unit instructions									
I/O REFRESH	IORF	IORF	**						
7-SEGMENT DECODER	SDEC	SDEC	**						
7-SEGMENT DISPLAY OUTPUT	7SEG	7SEG	*			3->4		Set the address of First destination word.	
DIGITAL SWITCH	DSW	DSW	*			3->5		Set the Number of Digits and System Word.	
TEN KEY INPUT	TKY	TKY	**						
HEXADECIMAL KEY INPUT	HKY	HKY	*			3->4		Set the first register word.	
I/O COMMAND TRANSMISSION	IOTC	-	x						
Serial communications instructions									
PROTOCOL MACRO	PMCR	PMCR	*		Expansion ->260	3->4	Send/Receive sequence No.: BCD -> BIN Number of send/receive words: BCD -> BIN	Set the communications port and destination unit address. Enter the send/receive sequence No in the Operand2 (C2).	Change related relay settings.
TRANSMIT	TXD	TXD	*		48->236		Number of bytes specifies in words: BCD -> BIN		Peripheral port/serial communication can not be selected for port specifier. Change related relay settings.
RECEIVE	RXD	RXD	*		47->235		Number of bytes to store specified in words: BCD -> BIN		Peripheral port/serial communication can not be selected for port specifier. Change related relay settings.
CHANGE SERIAL PORT SETUP	STUP	STUP	*		Expansion ->237	3->2		Port specification method is changed.	Settings after turning off/on power: stored -> reset change the related relay settings.
Network instructions									
NETWORK SEND	SEND	SEND	*					Set the control data again.	Control data: 4 words -> 5 words Change related relays.
NETWORK RECEIVE	RECV	RECV	*					Set the control data again.	Control data: 4 words -> 5 words Change related relays.
DELIVER COMMAND	CMND	CMND	*		Expansion ->490			Set the control data again.	Control data: 5 words -> 6 words Change related relays.
Display instructions									
MESSAGE	MSG	MSG	*			1->2		Set the message number in the Operand1.	
Clock instructions									
HOURS TO SECONDS	SEC	SEC	**		Expansion ->65	3 (None)->2			
SECONDS TO HOURS	HMS	HMS	**		Expansion ->66	3 (None)->2			
Debugging instructions									
TRACE MEMORY SAMPLE	TRSM	TRSM	**						Change related relays.
Failure diagnosis instructions									
FAILURE ALARM AND RESET	FAL	FAL	*			1->2		In Operand, enter FAL00: Clears the non-fatal error with the corresponding FAL number. Not FAL00: Word to send message or Error code to generate or word containing the error details	
SEVERE FAILURE ALARM	FALS	FALS	*			1->2		In Operand2, set First message word or error code and error details	
FAILURE POINT DETECT	FPD	FPD	*				Monitoring time specified in words: BCD ->BIN	Configure the operands again if diagnostic output mode is set in Bit address and message output.	Output area: When output in codes = 2 words -> 4 words When output in character = 9 words -> 10 words
Other instructions									
SET CARRY	STC	STC	**						
CLEAR CARRY	CLC	CLC	**						
High-speed counter/pulse output instructions									
MODE CONTROL	INI	INI	*		61->880		First word with new PV: BCD ->BIN	Refer to 5.1 High-speed counter/pulse output instruction.	
HIGH-SPEED COUNTER PV READ	PRV	PRV	*		62->881		PV output in BCD -> BIN.	Refer to 5.1 High-speed counter/pulse output instruction.	Configure the reference position of status data.
COMPARISON TABLE LOAD	CTBL	CTBL	*		63->883		Number of target values/target value/Interrupt task number: BCD -> BIN	Refer to 5.1 High-speed counter/pulse output instruction.	In Ring mode, enter the ring value in the PLC settings. Interrupt program: interrupt subroutine -> interrupt task (Also change the task No.).
SET PULSES	PULS	PULS	*		65->886		Number of pulses: BCD -> BIN	Refer to 5.1 High-speed counter/pulse output instruction.	
SPEED OUTPUT	SPED	SPED	*		64->885		Target frequency specified in words: BCD -> BIN	Refer to 5.1 High-speed counter/pulse output instruction.	
ACCELERATION CONTROL	ACC	ACC	*		Expansion ->888		Acceleration/deceleration rate/target frequency: BCD -> BIN	Refer to 5.1 High-speed counter/pulse output instruction.	
PULSE OUTPUT	PLS2	PLS2	*		Expansion ->887	3->4	Acceleration/deceleration rate/target frequency/number of output pulses: BCD -> BIN	Refer to 5.1 High-speed counter/pulse output instruction.	
PULSE WITH VARIABLE DUTY FACTOR	PWM	PWM	*		Expansion ->891		Duty factor specified in words: BCD ->BIN	Refer to 5.1 High-speed counter/pulse output instruction.	

Conversion: *** = same condition flag operation, ** = a part of condition flag operation differs, - = Different condition flag operation, None = no corresponding instruction
 Condition flags: Left of "/" = Operation of CQM1H. Right of "/" = Operation of CJ1M/CJ1G/CJ2M No "/" = Same operation in CQM1H and CJ
 * = ON/OFF depending on the instruction status

Instructions	CQM1H	CJ1M/CJ1G /CJ2M	Conversion	Condition flags ((CJ) = CQM1H does not have this settings.)										
				ER	GT(>)	GE (CJ)	EQ(=)	NE (CJ)	LT(<)	LE(CJ)	CY	UF	OF	N (CJ)
Sequence input instructions														
LOAD	LD	LD	***											
LOAD NOT	LD NOT	LD NOT	***											
AND	AND	AND	***											
AND NOT	AND NOT	AND NOT	***											
OR	OR	OR	***											
OR NOT	OR NOT	OR NOT	***											
AND LOAD	AND LD	AND LD	***											
OR LOAD	OR LD	OR LD	***											
Sequence output instructions														
OUTPUT	OUT	OUT	***											
OUTPUT NOT	OUT NOT	OUT NOT	***											
TR Bits	TR	TR	***											
KEEP	KEEP	KEEP	***											
DIFFERENTIATE UP	DIFU	DIFU	***											
DIFFERENTIATE DOWN	DIFD	DIFD	***											
SET	SET	SET	***											
RSET	RSET	RSET	***											
Sequence control instructions														
END	END	END	-	OFF/	OFF/		OFF/			OFF/	OFF/	OFF/		
NO OPERATION	NOP	NOP	***											
INTERLOCK	IL	IL	***											
INTERLOCK CLEAR	ILC	ILC	***											
JUMP	JMP	JMP	-	/*										
JUMP END	JME	JME	***											
Timer and counter instructions														
TIMER	TIM	TIM	***	*										
HIGH-SPEED TIMER	TIMH	TIMH	***	*										
TOTALIZING TIMER	TTIM	TTIM	***	*										
COUNTER	CNT	CNT	***	*										
REVERSIBLE COUNTER	CNTR	CNTR	***	*										
Comparison instructions														
COMPARE	CMP	CMP	**	*	*	/*	*	/*	*	/*				
DOUBLE COMPARE	CMPL	CMPL	**	*	*	/*	*	/*	*	/*				
SIGNED BINARY COMPARE	CPS	CPS	**	*	*	/*	*	/*	*	/*				
DOUBLE SIGNED BINARY COMPARE	CPSL	CPSL	**	*	*	/*	*	/*	*	/*				
MULTI-WORD COMPARE	MCMP	MCMP	***	*			*							
TABLE COMPARE	TCMP	TCMP	**	*/OFF			*							
BLOCK COMPARE	BCMP	BCMP	**	*			/*							
AREA RANGE COMPARE	ZCP	ZCP	***	*	*		*			*				
DOUBLE AREA RANGE COMPARE	ZCPL	ZCPL	***	*	*		*			*				
Data movement instructions														
MOVE	MOV	MOV	**	*			*							/*
MOVE NOT	MVN	MVN	**	*			*							/*
MOVE BIT	MOVB	MOVB	***	*										
		MOVBC	***	*										
		[Ver.3.0 or later]												
MOVE DIGIT	MOVD	MOVD	***	*										
TRANSFER BITS	XFRB	XFRB	-	*/OFF										
BLOCK TRANSFER	XFER	XFER	-	*/OFF										
		XFERC	***	*										
		[Ver.3.0 or later]												
BLOCK SET	BSET	BSET	***	*										
DATA EXCHANGE	XCHG	XCHG	-	*/										
SINGLE WORD DISTRIBUTE	DIST	DIST	**	*/OFF			*							/*
		DISTC	**	*			*							/*
		[Ver.3.0 or later]												
DATA COLLECT	COLL	COLL	**	*/OFF			*							/*
		COLLC	**	*			*							/*
		[Ver.3.0 or later]												
Data shift instructions														
SHIFT REGISTER	SFT	SFT	-	/*										
REVERSIBLE SHIFT REGISTER	SFTR	SFTR	***	*										
ASYNCHRONOUS SHIFT REGISTER	ASFT	ASFT	***	*										
WORD SHIFT	WSFT	WSFT	***	*										
ARITHMETIC SHIFT LEFT	ASL	ASL	**	*/OFF			*			*				/*
ARITHMETIC SHIFT RIGHT	ASR	ASR	**	*/OFF			*			*				*/OFF
ROTATE LEFT	ROL	ROL	**	*/OFF			*			*				/*
ROTATE RIGHT	ROR	ROR	**	*/OFF			*			*				/*
ONE DIGIT SHIFT LEFT	SLD	SLD	***	*										
ONE DIGIT SHIFT RIGHT	SRD	SRD	***	*										
Increment/ decrement instructions														
INCREMENT	INC	++B	**	*			*				/*			
BCD DECREMENT	DEC	--B	**	*			*				/*			

Conversion: *** = same condition flag operation, ** = a part of condition flag operation differs, - = Different condition flag operation, None = no corresponding instruction
 Condition flags: Left of "/" = Operation of CQM1H. Right of "/" = Operation of CJ1M/CJ1G/CJ2M No "/" = Same operation in CQM1H and CJ
 * = ON/OFF depending on the instruction status

Instructions	CQM1H	CJ1M/CJ1G /CJ2M	Conversion	Condition flags ((CJ) = CQM1H does not have this settings.)									
				ER	GT(>)	GE (CJ)	EQ(=)	NE (CJ)	LT(<)	LE(CJ)	CY	UF	OF
Symbol math instructions													
BINARY ADD	ADB	+C	**	*/OFF			*				*	*	/*
DOUBLE BINARY ADD	ADBL	+CL	**	*/OFF			*				*	*	/*
BCD ADD	ADD	+BC	***	*			*				*		
DOUBLE BCD ADD	ADDL	+BCL	***	*			*				*		
BINARY SUBTRACT	SBB	-C	**	*/OFF			*				*	*	/*
DOUBLE BINARY SUBTRACT	SBBL	-CL	**	*/OFF			*				*	*	/*
BCD SUBTRACT	SUB	-BC	***	*			*				*		
DOUBLE BCD SUBTRACT	SUBL	-BCL	***	*			*				*		
SIGNED BINARY MULTIPLY	MBS	*	**	*/OFF			*						/*
DOUBLE SIGNED BINARY MULTIPLY	MBSL	*L	**	*/OFF			*						/*
BINARY MULTIPLY	MLB	*U	**	*/OFF			*						/*
BCD MULTIPLY	MUL	*B	***	*			*						
DOUBLE BCD MULTIPLY	MULL	*BL	***	*			*						
SIGNED BINARY DIVIDE	DBS	/	**	*			*						/*
DOUBLE SIGNED BINARY DIVIDE	DBSL	/L	**	*			*						/*
BINARY DIVIDE	DVB	/U	**	*			*						/*
BCD DIVIDE	DIV	/B	***	*			*						
DOUBLE BCD DIVIDE	DIVL	/BL	***	*			*						
Conversion instructions													
BCD-TO-BINARY	BIN	BIN	**	*			*						*/OFF
DOUBLE BCD-TO-DOUBLE BINARY	BINL	BINL	**	*			*						*/OFF
BINARY TO BCD	BCD	BCD	***	*			*						
DOUBLE BINARY-TO-DOUBLE BCD	BCDL	BCDL	***	*			*						
2'S COMPLEMENT	NEG	NEG	**	*/OFF			*				*/		/*
DOUBLE 2'S COMPLEMENT	NEGL	NEGL	**	*/OFF			*				*/		/*
4-TO-16 DECODER	MLPX	MLPX	***	*			*						
16-TO-4 ENCODER	DMPX	DMPX	***	*			*						
ASCII CONVERT	ASC	ASC	***	*			*						
ASCII-TO-HEXADECIMAL	HEX	HEX	***	*			*						
LINE	LINE	LINE	***	*			*						
LINE TO COLUMN	COLM	COLM	***	*			*						
Logic instructions													
LOGICAL AND	ANDW	ANDW	**	*/OFF			*						/*
LOGICAL OR	ORW	ORW	**	*/OFF			*						/*
EXCLUSIVE OR	XORW	XORW	**	*/OFF			*						/*
EXCLUSIVE NOR	XNRW	XNRW	**	*/OFF			*						/*
COMPLEMENT	COM	COM	**	*/OFF			*						/*
Special math instructions													
BSQUARE ROOT	ROOT	ROOT	***	*			*						
ARITHMETIC PROCESS	APR	APR	**	*			*						/*
BIT COUNTER	BCNT	BCNT	***	*			*						
		BCNTC	***	*			*						
		[Ver.3.0 or later]											
Floating point math instructions													
FLOATING TO 16-BIT	FIX	FIX	**	*			*						/*
FLOATING TO 32-BIT	FIXL	FIXL	**	*			*						/*
16-BIT TO FLOATING	FLT	FLT	**	*/			*						/*
32-BIT TO FLOATING	FTL	FTL	**	*/			*						/*
FLOATING-POINT ADD	+F	+F	**	*			*				*	*	/*
FLOATING-POINT SUBTRACT	-F	-F	**	*			*				*	*	/*
FLOATING-POINT MULTIPLY	*F	*F	**	*			*				*	*	/*
FLOATING-POINT DIVIDE	/F	/F	**	*			*				*	*	/*
DEGREES TO RADIANS	RAD	RAD	**	*			*				*	*	/*
RADIANS TO DEGREES	DEG	DEG	**	*			*				*	*	/*
SINE	SIN	SIN	**	*			*				OFF/	OFF/	/*
COSINE	COS	COS	**	*			*				OFF/	OFF/	/*
TANGENT	TAN	TAN	**	*			*				OFF/	***	/*
ARC SINE	ASIN	ASIN	**	*			*				OFF/	OFF/	/*
ARC COSINE	ACOS	ACOS	**	*			*				OFF/	OFF/	/*
ARC TANGENT	ATAN	ATAN	**	*			*				OFF/	OFF/	/*
SQUARE ROOT	SQRT	SQRT	**	*			*				OFF/	*	/*
EXPONENT	EXP	EXP	***	*			*				*	*	/*
LOGARITHM	LOG	LOG	**	*			*				OFF/	*	/*
Table data processing instructions													
DATA SEARCH	SRCH	SRCH	***	*			*						
FIND MAXIMUM	MAX	MAX	**	*			*						/*
FIND MINIMUM	MIN	MIN	**	*			*						/*
SUM	SUM	SUM	**	*			*						/*
FCS CALCULATE	FCS	FCS	***	*			*						
Data control instructions													
PID CONTROL	PID	PID	**	*		/*				/*	*		
SCALING	SCL	SCL	***	*			*						
SIGNED BINARY TO BCD SCALING	SCL2	SCL2	***	*			*				*		
BCD TO SIGNED BINARY SCALING	SCL3	SCL3	***	*			*						/*
AVERAGE VALUE	AVG	AVG	***	*			*						
Subroutines instructions													
SUBROUTINE ENTRY	SBS	SBS	***	*			*						
MACRO	MCRO	MCRO	***	*			*						
SUBROUTINE DEFINE	SBN	SBN	***	*			*						
SUBROUTINE RETURN	RET	RET	***	*			*						

Conversion: *** = same condition flag operation, ** = a part of condition flag operation differs, - = Different condition flag operation, None = no corresponding instruction
 Condition flags: Left of "/" = Operation of CQM1H. Right of "/" = Operation of CJ1M/CJ1G/CJ2M No "/" = Same operation in CQM1H and CJ
 * = ON/OFF depending on the instruction status

Instructions	CQM1H	CJ1M/CJ1G /CJ2M	Conversion	Condition flags ((CJ) = CQM1H does not have this settings.)										
				ER	GT(>)	GE (CJ)	EQ(=)	NE (CJ)	LT(<)	LE(CJ)	CY	UF	OF	N (CJ)
Interrupt control instructions														
INTERRUPT CONTROL	INT	MSKS MSKR CLI DI EI	None	*										
INTERVAL TIMER	STIM	MSKS MSKR	None	*										
Step instructions														
STEP DEFINE	STEP	STEP	-	/*										
STEP START	SNXT	SNXT	-	/*										
Basic I/O Unit instructions														
I/O REFRESH	IORF	IORF	-	/*										
7-SEGMENT DECODER	SDEC	SDEC	***	*										
7-SEGMENT DISPLAY OUTPUT	7SEG	7SEG [Ver.2.0 or later]	-	*/										
DIGITAL SWITCH	DSW	DSW [Ver.2.0 or later]	-	*/										
TEN KEY INPUT	TKY	TKY [Ver.2.0 or later]	-	*/										
HEXADECIMAL KEY INPUT	HKY	HKY [Ver.2.0 or later]	-	*/										
IO COMMAND TRANSMISSION	IOTC	-	None	*										
Serial communications instructions														
PROTOCOL MACRO	PMCR	PMCR	***	*										
TRANSMIT	TXD	TXD	***	*										
RECEIVE	RXD	RXD	***	*										
CHANGE SERIAL PORT SETUP	STUP	STUP	***	*										
Network instructions														
NETWORK SEND	SEND	SEND	***	*										
NETWORK RECEIVE	RECV	RECV	***	*										
DELIVER COMMAND	CMND	CMND	***	*										
Display instructions														
MESSAGE	MSG	MSG	***	*										
Clock instructions														
HOURS TO SECONDS	SEC	SEC	***	*			*							
SECONDS TO HOURS	HMS	HMS	***	*			*							
Debugging instructions														
TRACE MEMORY SAMPLE	TRSM	TRSM	***											
Failure diagnosis instructions														
FAILURE ALARM AND RESET	FAL	FAL	-	/*										
SEVERE FAILURE ALARM	FALS	FALS	-	/*								*		
FAILURE POINT DETECT	FPD	FPD	***	*										
Other instructions														
SET CARRY	STC	STC	***									ON		
CLEAR CARRY	CLC	CLC	***									OFF		
High-speed counter/pulse output instructions														
MODE CONTROL	INI	INI	***	*										
HIGH-SPEED COUNTER PV READ	PRV	PRV	***	*								ON/OFF depending on instruction operation (CJ2M only)		
COMPARISON TABLE LOAD	CTBL	CTBL	***	*										
SET PULSES	PULS	PULS	***	*										
SPEED OUTPUT	SPED	SPED	***	*										
ACCELERATION CONTROL	ACC	ACC	***	*										
PULSE OUTPUT	PLS2	PLS2	***	*										
PULSE WITH VARIABLE DUTY FACTOR	PWM	PWM	***	*										

Note: Do not use this document to operate the Unit.

OMRON Corporation Industrial Automation Company

Tokyo, JAPAN

Contact: www.ia.omron.com

Regional Headquarters

OMRON EUROPE B.V.

Wegalaan 67-69, 2132 JD Hoofddorp
The Netherlands
Tel: (31)2356-81-300/Fax: (31)2356-81-388

OMRON ELECTRONICS LLC

2895 Greenspoint Parkway, Suite 200
Hoffman Estates, IL 60169 U.S.A
Tel: (1) 847-843-7900/Fax: (1) 847-843-7787

OMRON ASIA PACIFIC PTE. LTD.

No. 438A Alexandra Road # 05-05/08 (Lobby 2),
Alexandra Technopark,
Singapore 119967
Tel: (65) 6835-3011/Fax: (65) 6835-2711

OMRON (CHINA) CO., LTD.

Room 2211, Bank of China Tower,
200 Yin Cheng Zhong Road,
PuDong New Area, Shanghai, 200120, China
Tel: (86) 21-5037-2222/Fax: (86) 21-5037-2200

Authorized Distributor:

© OMRON Corporation 2015 All Rights Reserved.
In the interest of product improvement,
specifications are subject to change without notice.

Cat. No. P0, +E1-0%

0415