



Cat. No. W161-E1-3A

**SYSMAC
S3200-LSU03-01E
Line Server**

INSTALLATION GUIDE

OMRON

Notice:

OMRON products are manufactured for use according to proper procedures by a qualified operator and only for the purposes described in this manual.

The following conventions are used to indicate and classify precautions in this manual. Always heed the information provided with them. Failure to heed precautions can result in injury to people or damage to the product.

DANGER! Indicates information that, if not heeded, is likely to result in loss of life or serious injury.

WARNING Indicates information that, if not heeded, could possibly result in loss of life or serious injury.

Caution Indicates information that, if not heeded, could result in relative serious or minor injury, damage to the product, or faulty operation.

OMRON Product References

All OMRON products are capitalized in this manual. The word "Uni" is also capitalized when it refers to an OMRON product, regardless of whether or not it appears in the proper name of the product.

The abbreviation "Ch," which appears in some displays and on some OMRON products, often means "word" and is abbreviated "Wd" in documentation in this sense.

The abbreviation "PC" means Programmable Controller and is not used as an abbreviation for anything else.

Visual Aids

The following headings appear in the left column of the manual to help you locate different types of information.

Note Indicates information of particular interest for efficient and convenient operation of the product.

1, 2, 3... 1. Indicates lists of one sort or another, such as procedures, checklists, etc.

© OMRON, 1989

All rights reserved. No part of this publication may be reproduced, stored in a retrieval system, or transmitted, in any form, or by any means, mechanical, electronic, photocopying, recording, or otherwise, without the prior written permission of OMRON.

No patent liability is assumed with respect to the use of the information contained herein. Moreover, because OMRON is constantly striving to improve its high-quality products, the information contained in this manual is subject to change without notice. Every precaution has been taken in the preparation of this manual. Nevertheless, OMRON assumes no responsibility for errors or omissions. Neither is any liability assumed for damages resulting from the use of the information contained in this publication.

TABLE OF CONTENTS

SECTION 1	
Introduction	1
1-1 Introduction	2
1-2 Block Diagram	3
1-3 Indicators	3
1-4 System Configurations	4
SECTION 2	
Installation	7
2-1 Introduction	8
2-2 Optical Fiber Cable	8
2-3 Nomenclature	8
2-4 DIP Switch Setting	9
2-5 Wiring	9
2-6 Connecting the Network	10
Appendix A	
Standard Models	13
Appendix B	
Dimensions	15
Appendix C	
Specifications	17
Glossary	19
Index	21
Revision History	23

About this Manual:

This manual explains how to install and operate the Line Server Unit within a SYSMAC Net LAN (Local Area Network). Information concerning SYSMAC Net LAN architecture can be found in the SYSMAC Net System Manual. Information concerning individual components of the LAN can be found in their respective manuals.

Section 1 Introduction, explains the switches and indicators of the Unit. The Line Server's function on the network and possible system configurations are also discussed.

Section 2 Installation, discusses the Line Server's settings and the necessary wiring to other network nodes.

Appendices, a glossary and index are located at the back of this manual.

Please thoroughly familiarize yourself with the contents of this manual before operating the Line Server Unit.

SECTION 1

Introduction

1-1	Introduction	2
1-2	Block Diagram	3
1-3	Indicators	3
1-4	System Configurations	4

1-1 Introduction

The SYSMAC Net LAN (Local Area Network) is based on token ring architecture. Network nodes are arranged in a loop configuration, connected together with Optical Fiber Cables. Communication among nodes is organized by the circulation of a token around the network loop. The node currently in possession of the token has the right to begin transmitting its data.

The Line Server Unit is responsible for issuing and monitoring the network token. If the Line Server Unit does not detect the token's return in a set amount of time, it issues a new token. No other network node has the ability to re-issue the token. Up to 126 network nodes may be connected in a loop configuration using the Optical Fiber Cables.

Each network loop must have a single Line Server Unit. If the network loop's Line Server Unit fails, LAN communication stops.

If the network loop is extended to distances exceeding 1 km, a second Line Server Unit may be set to function as a repeater. For even longer distances, two repeaters may be connected adjacent to one another using special AGF (all glass fiber) cable. Refer to *Section 1-4 System Configurations* for more information.

The token is used to keep communication along the network loop organized and dependable. When a node receives the token, it has the right to begin transmitting information to other nodes of the network loop. Data is usually sent in packets called datagrams. Refer to the SYSMAC Net System Manual for more information regarding format of these packets.

The Line Server is also responsible for coordinating the back loop function if an error is detected on the network loop. The back loop function is initiated if the normal loop around which the token is passed becomes obstructed. In this event, the token reverses direction before the obstruction by using the back loop path. The back loop thus ensures that the token continues to circulate even in damaged network loops.

With an internal setting, the Line Server can work as a long-distance repeater without issuing and monitoring the network token.

This section will describe the functions of the Line Server Unit's switches and indicators. Several possible system configurations are discussed with instructions for connecting the Unit onto the network.

Setting the Line Server Unit to function as a repeater is also described.

1-2 Block Diagram

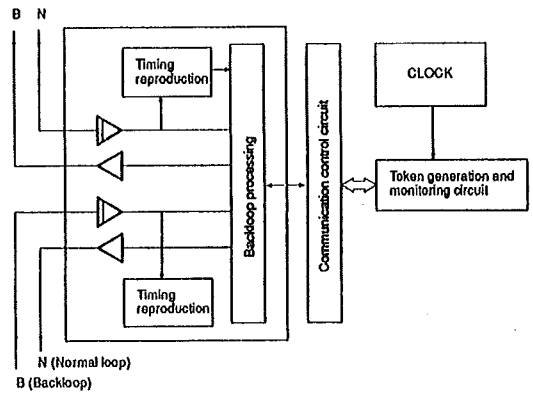

1-3 Indicators

Front Panel

The Line Server has four LED indicators on the front panel. These indicators are used to determine the Line Server's status.

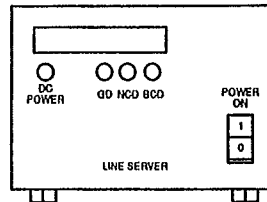

Item	Explanation
POWER ON switch	Press the upper side of the POWER ON switch to turn the Unit on.
DC Power Indicator (green)	Lit when the Unit is powered ON.
GD Indicator (red)	Lit when the token passes through this Unit and flashes when the token is circulating along the loop. The intensity of light decreases if there is a loop error.
NCD Indicator (red)	Normal Carrier Detect. Lit when there is a normal loop reception signal.
BCD Indicator (red)	Back loop Carrier Detect. Lit when there is a back loop reception signal.

The following chart describes how to interpret the NCD and BCD indicators.

LED	Loop Status
NCD and BCD lit	Normal
NCD lit, BCD blinking	Upstream Back loop
NCD blinking, BCD lit	Downstream Back loop
NCD and BCD unlit	Loop Error

Back Panel

The back panel of the Line Server Unit is used to connect the Optical Fiber Cables and the power supply. Two kinds of Optical Fiber Cable may be used: standard HC-PCF (hard core plastic clad fiber) cable, or AGF (all glass fiber) quartz crystal cable for networks that require distances up to 3 km between repeaters. If using the quartz crystal cable, the Line Server Unit must be modified by OMRON factory personnel. The following figure shows the back panel of the Line Server.

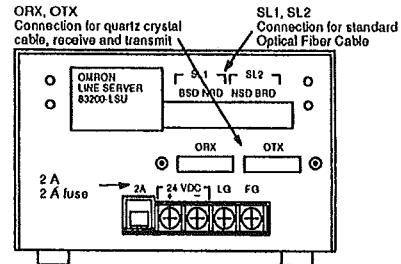

1-4 System Configurations

The Line Server has a DIP switch that allows the Unit to be set as either a Line Server or a repeater. Each network loop may have only one Line Server node. Up to two Units may be set to function as repeaters.

The DIP switch is also used to set the amount of time the Unit should wait for the token to be returned before issuing a new one. Refer to *Section 2-4 DIP Switch Settings* for additional information.

A typical system configuration contains several types of nodes. PC-AT compatible computers are attached to the SYSMAC Net LAN with the SYSMAC Net Support Board and software. C-series PCs are attached using the SYSMAC Net Link Unit. Serial devices are attached using the SYSMAC Net Service Unit. Separate network loops are allowed to communicate across SYSMAC Bridge Units. Local Power Supply Units and Net Link Adapters may be

added for increased reliability. The following diagram illustrates a typical system configuration.

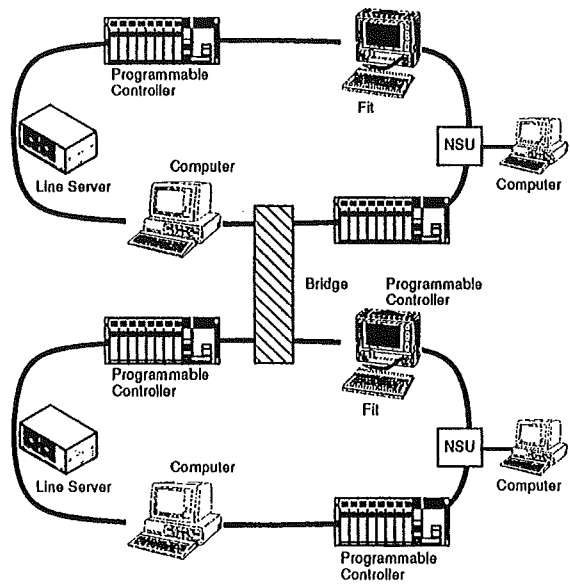

Up to 126 nodes may be attached onto the Line Server's network loop. If more nodes will be required, then separate network loops should be established with Bridge Units joining the LANs. Total distance of a single network loop should be 1 km when using the standard Optical Fiber Cabling. Quartz crystal cabling is advantageous for some installations, but this cabling requires more difficult connector assembly and requires factory modifications of the Line Server Unit.

A Line Server can be set to function as a repeater in networks that extend to distances over 1 km. In this instance the network loop may have more than one Line Server because the function of additional Units is to receive, amplify, and re-transmit the network's token. No more than two repeaters should be used in a single network loop, but this allows the total distance to be 3 km. The next diagram shows a system configuration where the total network dis-

tance is 3 km. Network nodes may be installed anywhere along the three 1 km spans.

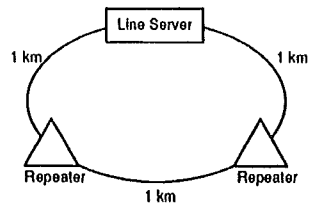

If the distance of the network loop must be extended beyond the 3 km limit using two repeaters, then the quartz crystal cable may be used with the Line Server. This cable is used to connect two Line Servers set as repeaters separated by up to 3 km. The ORX and OTX connections,

as well as the SL1 and SL2 connections, on the back panel are used after a modification is made to the Unit's internal board. No nodes are installed in the span between the two Units serving as repeaters. The next diagram shows a system configuration where total distance of the network loop is 5 km.

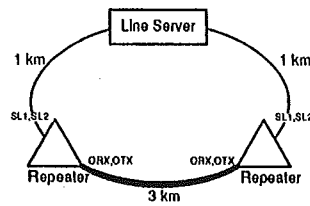

SECTION 2 Installation

2-1	Introduction	8
2-2	Optical Fiber Cable	8
2-3	Nomenclature	8
2-4	DIP Switch Setting	9
2-5	Wiring	9
2-6	Connecting the Network	10

able. Terminals 1 of NRD, BSD, BRD, and NSD are short-circuited before shipping.



2-4 DIP Switch Setting

The Line Server uses a DIP switch to set the token monitoring time, and to determine whether the Unit will function as a Line Server or as a repeater for the network loop. Networks with cable distances greater than 1 km require the use of a repeater.

The DIP switch is accessed by removing the four screws that secure the Line Server's case. The switch is located on the Line Server's circuit board. The following figure indicates standard DIP switch settings before shipping.

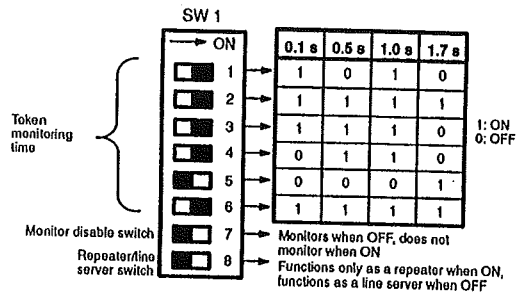

Only one Line Server per loop can have both pins 7 and 8 set to OFF, thus functioning as a Line Server. When the Unit is being used as a repeater, set pin 8 to ON.

As the above DIP switch figure shows, pins 1 through 6 are used to set the token monitoring time. LANs with many nodes, and LANs running applications using many data transfers, require longer monitoring times because the token needs more time to be passed around the network loop.

If the token is not returned at the interval set with these 6 pins, a new token will be issued. Setting the monitoring time for 1 second is standard. This is true as long as pin 7, the monitor disable switch, is set to OFF. If the monitor disable switch is set to ON, then the Unit

will not watch for the token. During normal operation this pin should be set to the OFF position so that the Unit will monitor the network loop's token. Pin 8 determines if the Unit will function as a Line Server or as a repeater. This pin should be set to OFF for Line Server operation, and ON for repeater operation.

2-5 Wiring

The Line Server's back panel is used to attach the Optical Fiber Cable and the electrical connections. The following figure shows the power terminal

connections. Ensure that the line ground (LG) and frame ground (FG) are properly grounded as described.

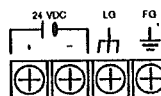

The ORX and OTX connections will not be used unless the AGF quartz crystal cabling is used between two Units functioning as repeaters.

Standard networks with HC-PCF cable use the SL1 and SL2 Optical Fiber Cable connections.

2-6 Connecting the Network

Connect the SYSMAC Net LAN one node at a time from the Line Server. By following this procedure, it will be easy to locate any node or cable connection problems.

- 1, 2, 3... 1. Draw a system configuration of the Line Server and nodes to be connected to the network.
2. Prepare the Optical Fiber Cable required between each of the nodes as described in the Optical Fiber Cable Installation Guide.
3. Verify that the Line Server is properly wired before switching it ON. Once powered ON, the DC power indicator lights and the GD, NCD, and BCD indicators blink.
4. Turn OFF the Line Server and the downstream node to be connected. Use the Optical Fiber Cable to connect the SL1 port of the Line Server to the SL2 port of the downstream node. Also connect the SL2 port of the Line Server to SL1 port of the downstream node. Verify that the downstream node is properly wired before switching the Line Server and the node ON. Apply power to the devices and confirm communication along both the normal and back loops. For the downstream node this can be determined by interpreting the indicators as described in its operation manual. The Line Server's GD and BCD indicators should be lit, and the NCD indicator should blink. This indicates that both the normal and back loops are connected. The back loop is occurring at the downstream node because the network loop is not fully constructed.

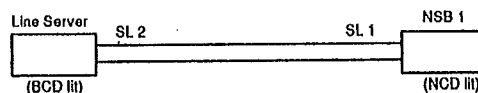

5. Continue connecting each node in a downstream direction from the Line Server, checking the indicators as each node is added. The node LEDs at the ends of the chain will continue to indicate the back loop condition

until the loop is closed. If an error is found, check cable connections and node settings as described in the appropriate manual.

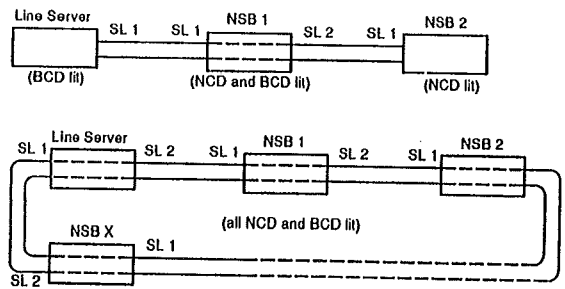

At least one computer equipped with a Network Support Board should be included on the network loop so that the diagnostic software can be used to troubleshoot errors.

Appendix A Standard Models

SYSMAC Net products are listed below with model numbers.

Name	Description	Part number
Line Server Unit	Creates and monitors the token; one Unit required for each network loop. A second Unit may also be set to function as repeater.	S3200-LSU003-01E
SYSMAC NET Link Unit	Network interface for C-series PCs.	C500-SNT31-V4
Network Support Board	Network interface for IBM AT compatible computers; includes software.	S3200-NSB11-E
Network Support Board for FIT	Network interface for Factory Intelligent Terminal.	FIT10-IF401
Network Bridge	Connects one network loop to another.	S3200-NSUG4-00E
Network Service Unit	Network interface for serial communication devices with two RS-232 ports	S3200-NSUA1-00E

Appendix B Dimensions

All dimensions are in millimeters unless otherwise specified.

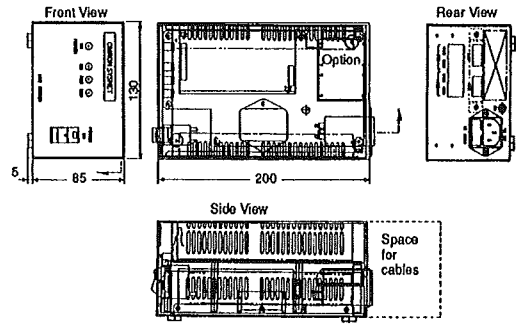

Appendix C Specifications

Standard Ratings

Item	Specification
Rated voltage	24 VDC
Operating voltage	20.4 to 28.8 VDC
Rated current	0.5 A max. (preliminary)
Operating temperature	0°C to 50°C
Storage temperature	-20°C to 65°C
Humidity	35% to 85%
Insulation resistance	20 MΩ at 500 VDC
Dielectric strength	1,000 VAC for 1 minute
Current leakage	3.5 mA max.
Power supply noise	1 kV peak to peak (100- to 950-ns pulse)
Instantaneous power failure	30 ms max.
Vibration resistance	15 to 50 Hz, 2G for 30 minutes each in X, Y, and Z directions
Shock resistance	10G (vertical drop)
Power cord	1.8-m long 3-pin square plug with ground terminal
Weight	Approximately 2 kg

Optical Characteristics of the LAN

Item	Specification
Transmission Speed	2M bps
Transmission distance	Up to 1 km when using Standard HC-PCF Optical Fiber Cable
Input/output level	TTL level

Glossary

Back loop	Alternative route data will automatically take around the loop if a problem is encountered on the otherwise-used normal loop. The direction of the data transmission in the nodes on either side of the fault is reversed so that all other devices on the network loop can continue to send and receive messages. The back loop function ensures that there is always a circular route for the token to be passed around the network loop.
Downstream	Direction the token normally circulates as it is passed from the Line Server Unit toward the first network node. The token continues to pass in the downstream direction around the network loop unless a communication problem occurs at a node or the Optical Fiber Cables. In this event, the automatic back loop function reverses the direction of the token.
Network loop	A group of interconnected SYSMAC Net nodes arranged so as to allow communication. With proper interface boards installed, possible SYSMAC Net devices include AT-compatible computers, C-series PCs, and the FIT. Serial devices may be accessed using a Network
Service Unit node	Nodes on separate network loops may communicate with each other if a Bridge Unit is used to connect the two network loops. Each network loop is limited to 126 nodes.
Repeater	If a Line Server DIP switch is set accordingly, the Unit can receive and retransmit the network's token so that the total distance of the network may be extended. Every network requires a Line Server, but repeaters are necessary only if the network's cabling exceeds 1 km.
Token	A signal the Line Server issues to network nodes that permits these nodes to transfer their data. The Line Server is the only device on the network loop that has the responsibility to issue this token. The token functions to keep communication on the network organized.
Upstream	Direction opposite to the flow of the network's token from the Line Server Unit.

Index

- A**
- AOF Cable, 8
- B**
- BCD, 3
- C**
- Connecting the Network, 9
- D**
- DC Power, 3
- DIP Switch, 8
- F**
- Frame Ground, 9
- Fuse, 3
- G**
- GD, 3
- H**
- HC-PCF Cable, 8
- I**
- Indicators, 2
- L**
- LED indicators, 2
- Line Ground, 9
- Loop Distances, 5
- Loop Status, 3
- M**
- Monitor Disable Switch, 8
- N**
- NCD, 3
- Nodes, 3
- O**
- Optical Fiber Cable, 8
- ORX/OTX, 3
- Q**
- Quartz Crystal Cable, 8
- R**
- Repeater, 4
- Repeater/Line Server Switch, 8
- S**
- SL1/SL2, 3
- T**
- Token Monitoring Time, 8
- W**
- Wiring, 9

Revision History

A manual revision code appears as a suffix to the catalog number on the front cover of the manual.

Cat. No. W161-E1-3A
 Revision code

The following table outlines the changes made to the manual during each revision. Page numbers refer to the previous version.

Revision code	Date	Revised content
1	July 1989	Original production
2	September 1989	General cleaning of text and graphics.
3	March 1990	Total revision of text and additional graphics added.
	December 1990	Converted to the current format.
3A	December 1993	<p>Page 2: Line server function description added to paragraph 2. Paragraph 7 added.</p> <p>Page 3: Circuit block diagram added at top of page and table at bottom of page modified.</p> <p>Page 8 and 9: Information in 2-3 <i>Nomenclature</i> added.</p> <p>Page 9: Graphic in 2-4 <i>DIP Switch Setting</i> modified.</p> <p>Page 13: Information in table modified.</p> <p>Page 15: Graphic added and section renamed.</p> <p>Page 17: Information in top table modified.</p>

OMRON Corporation
FA Systems Division H.Q.
66 Matsumoto
Mishima-city, Shizuoka 411-8511
Japan
Tel: (81)559-77-9181/Fax: (81)559-77-9045

Regional Headquarters

OMRON EUROPE B.V.
Wegalaan 67-69, NL-2132 JD Hoofddorp
The Netherlands
Tel: (31)2356-81-300/Fax: (31)2356-81-388

OMRON ELECTRONICS, INC.
1 East Commerce Drive, Schaumburg, IL 60173
U.S.A.
Tel: (1)847-843-7900/Fax: (1)847-843-8568

OMRON ASIA PACIFIC PTE. LTD.
83 Clemenceau Avenue,
#11-01, UE Square,
Singapore 239920
Tel: (65)835-3011/Fax: (65)835-2711

OMRON

Authorized Distributor: